



KOVANÉ POLOTOVARY

PRO BRÁNY, OPLOCENÍ A ZÁBRADLÍ

Forged steel components / Кованные элементы / Schmiedeeisen



SPIRÁLOVÉ PRVKY

scrolls / спиральные элементы / Spiralelemente



□	12X6	12X6	12X6	12X6	12X6	12X6	12X6	12X6	12X6	12X6
H	110	80	95	100	115	120	130	150	160	220
L	64	50	60	60	75	70	70	75	80	120
N°	10.090	10.091	10.092	10.093	10.094	10.095	10.096	10.097	10.098	10.099



□	12x6	12x6	12x6	12x6	12x6	12x6	12x6
H	150	230	260	170	195	300	330
L	70	115	115	80	90	120	130
N°	10.100	10.101	10.102	10.103	10.104	10.107	10.108



□	12x6	12x6	12x6	12x6
H	120	230	250	460
L	80	80	75	80
N°	10.109	10.116	10.125	10.130

SPIRÁLOVÉ PRVKY

scrolls / спиральные элементы / Spiralelemente



□	12X6	12X6	12X6	12X6	12X6	12X6
H	80	100	120	130	160	220
L	55	60	75	75	80	130
N°	10.200	10.201	10.202	10.203	10.204	10.205



□	12x6	12x6	12x6	12x6	12x6	12x6
H	150	170	220	270	300	330
L	70	80	100	110	120	130
N°	10.206	10.207	10.208	10.209	10.210	10.211



SPIRÁLOVÉ PRVKY

scrolls / спиральные элементы / Spiralelemente



□	12x6	12x6	12x6	12x6	12x6	12x6
H	120	120	260	260	200	180
L	60	60	65	75	100	120
N°	10.215	10.216	10.220	10.221	10.224	10.226



□	12x6	12x6	12x6	12x6
H	100	120	150	150
L	180	220	100	100
N°	10.230	10.231	10.240	10.241



□	12x6	12x6	12x6	12x6
H	190	190	150	150
L	140	140	100	100
N°	10.242	10.243	10.250	10.251

SPIRÁLOVÉ PRVKY

scrolls / спиральные элементы / Spiralelemente



□	12x12	12x12	12x12	12x12	12x12	12x12
H	100	120	130	150	190	220
L	70	75	80	82	123	128
N°	10.300	10.301	10.302	10.303	10.304	10.305



□	12x12	12x12	12x12	12x12
H	180	250	260	290
L	88	120	120	120
N°	10.310	10.311	10.312	10.313



SPIRÁLOVÉ PRVKY

scrolls / Spiralelemente / спиральные элементы / spirálové elementy

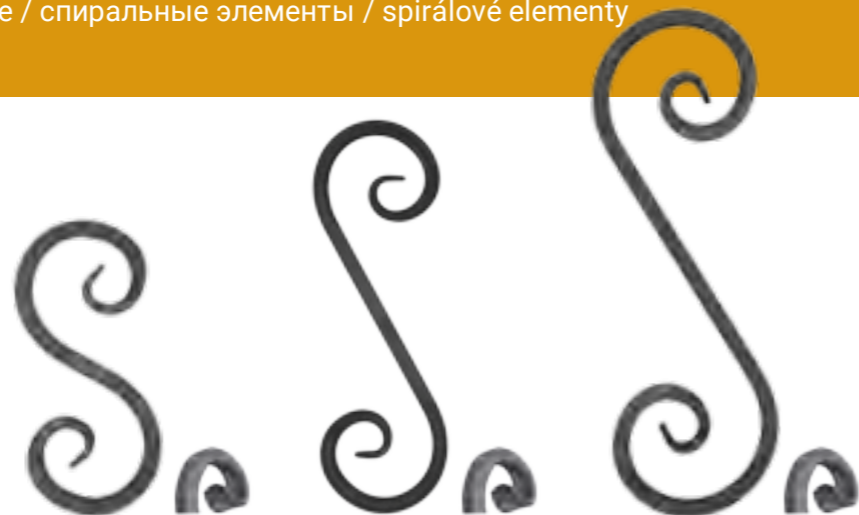

□	12x12	12x12	12x12
H	200	300	360
L	90	100	120
N°	10.315	10.316	10.317



□	12x12	12x12	12x12
H	125	135	175
L	65	65	95
N°	10.320	10.321	10.323

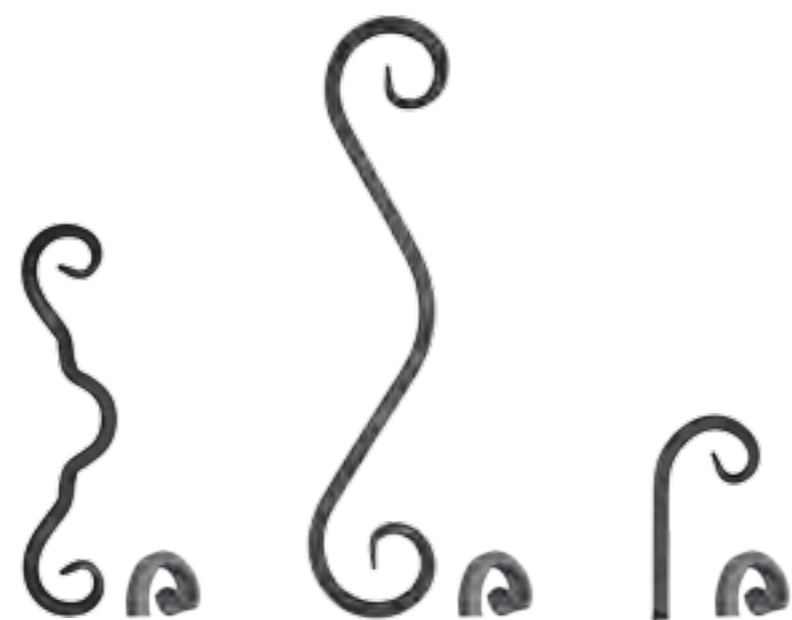

□	12x12	12x12	12x12
H	280	450	150
L	80	90	80
N°	10.328	10.330	10.340

SPIRÁLOVÉ PRVKY

scrolls / спиральные элементы / Spiralelemente



□	12x6	12x6	12x6	12x6	12x6
H	∅ 110	∅ 100	∅ 120	∅ 100	∅ 120
N°	11.030	11.031	11.032	11.041	11.042



□	12x6	12x6	12x6	12x6	12x6
H	80	100	190	190	100
L	80	100	100	120	115
N°	11.051	11.052	11.061	11.062	11.091

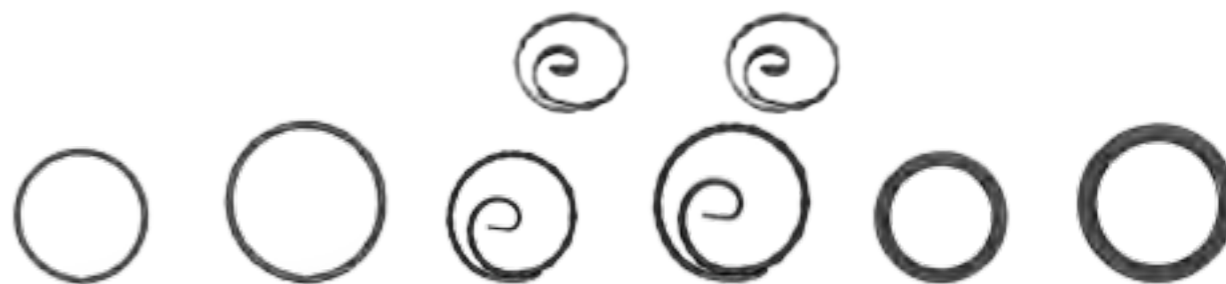

□	12x6	12x6	12x6	12x6	12x12	12x12
H	∅ 100	∅ 120	∅ 100	∅ 120	∅ 100	∅ 120
N°	11.231	11.232	11.241	11.242	11.331	11.332

KOŠÍKY

baskets / корзины / Zwirbeln



□	6x6	12x12	14x14
H	70	130	130
L	70	60	65
N°	12.010	12.080	12.081



□	16x16	20x20	24x24
H	145	165	180
L	65	100	95
N°	12.082	12.083	12.084



□	12x12	12x12	12x12
H	130	150	190
L	65	70	50
N°	12.111	12.112	12.113



KOŠÍKY

baskets / корзины / Zwirbeln



□	15x15	18x18	24x24
H	150	190	190
L	75	120	120
N°	12.115	12.118	12.124



□	16x16	16x16	12x12	12x12
H	160	210	200	330
L	85	85	50	63
N°	12.130	12.131	12.148	12.150



ORNAMENTY

rosettes / розетки / Rosetten

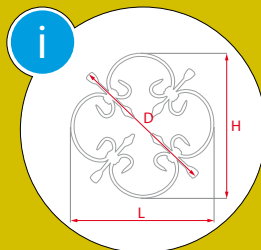

□	12x6	8x8	20x4
H	235	250	250
L	235	250	250
D	280	245	305
N°	13.000	13.003	13.005



□	12x12	12x12
H	375	320
L	300	250
N°	13.006	13.006.01

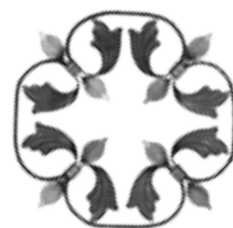

□	10x5	12x6
H	250	295
L	250	295
D	260	330
N°	13.007	13.008

ORNAMENTY

rosettes / розетки / Rosetten

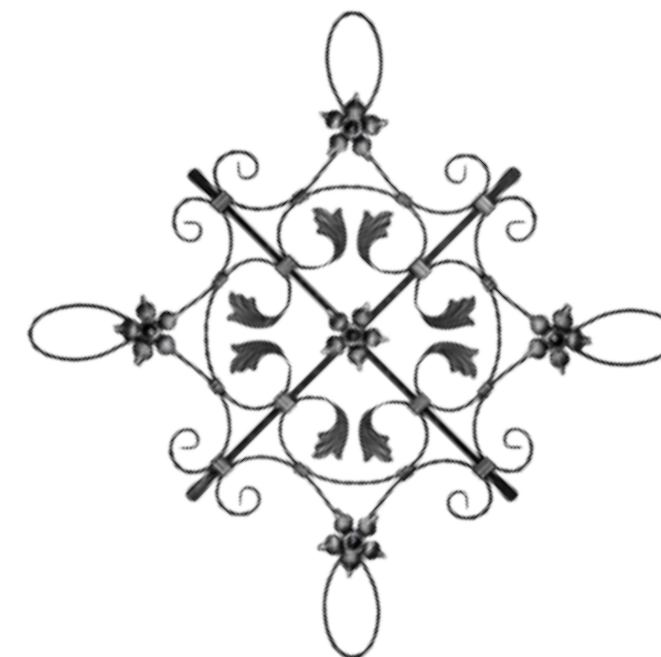
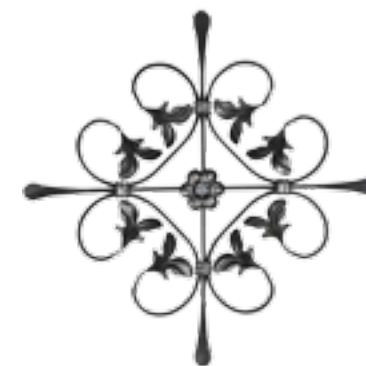

□	12x6	12x6
H	485	880
L	485	880
D	355	640
N°	13.009	13.010



□	12x12	16x8
H	900	700
L	900	650
D	630	
N°	13.011	13.012

ORNAMENTY

rosettes / розетки / Rosetten

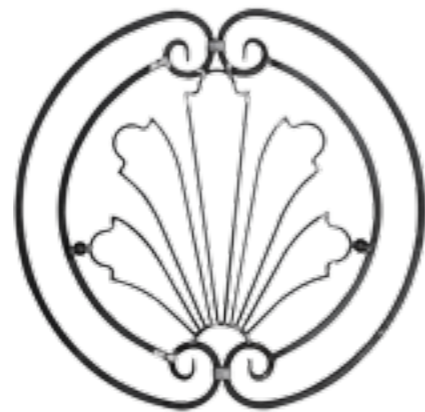
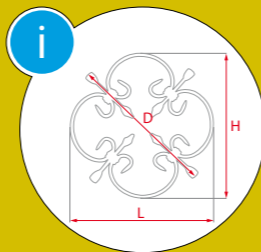

□	14x14	14x14
H	680	540
L	700	520
N°	13.013	13.013.01

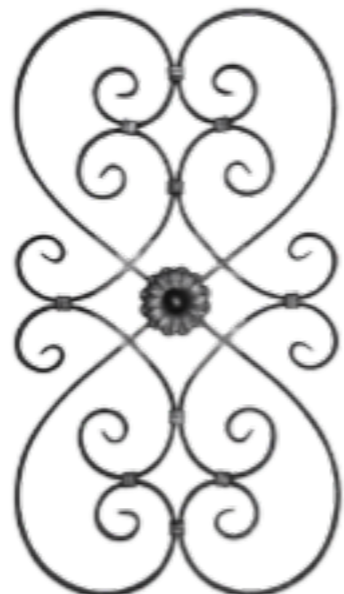
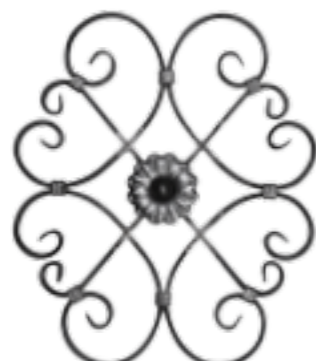
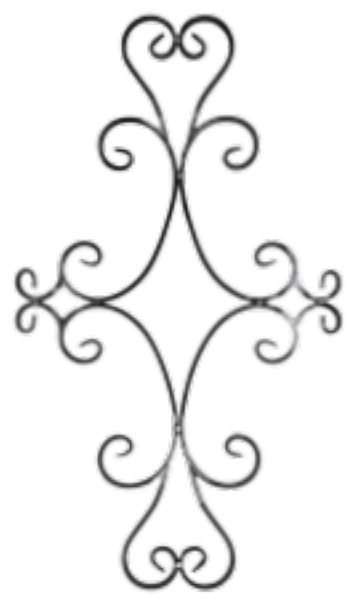

□	16x8	16x8	16x8
H	800	480	800
L	450	410	440
N°	13.015	13.016	13.017

ORNAMENTY

rosettes / розетки / Rosetten



□	12x12	∅13	10x10
H	530	530	530
L	420	420	420
N°	13.018	13.018.01	13.018.02

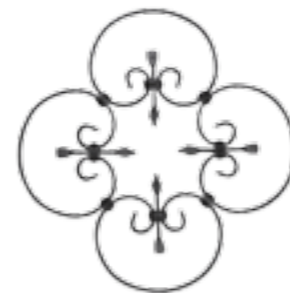

□	10x5	16x8	12x12
H	380	580	590
L	380	400	590
D	325		500
N°	13.020	13.023	13.025



ORNAMENTY

rosettes / розетки / Rosetten

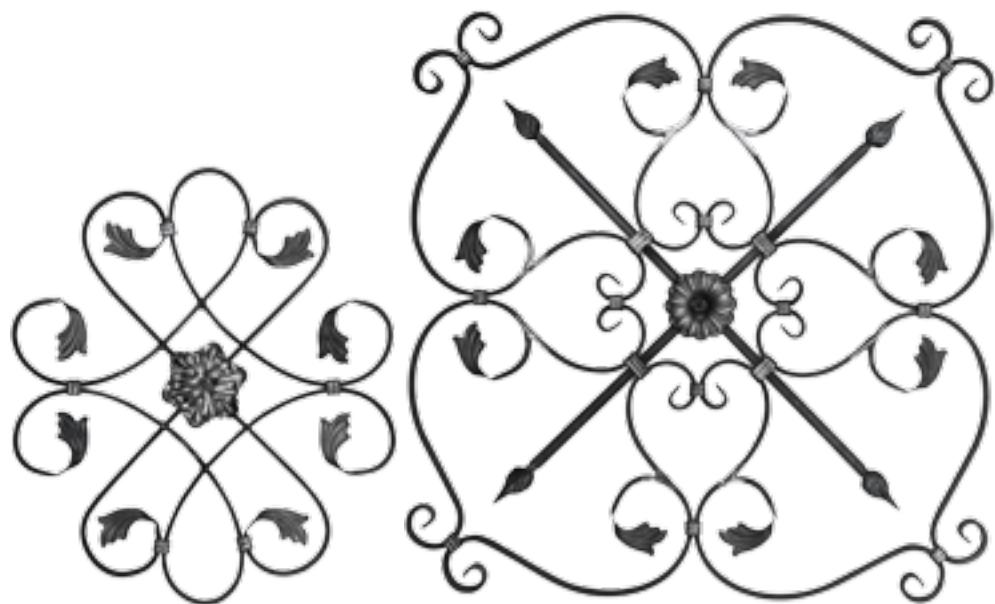
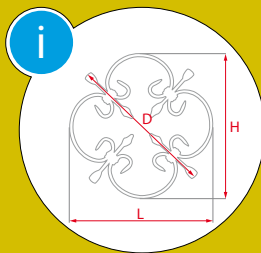

□	16x8	16x8
H	590	800
L	510	800
D		1025
N°	13.026	13.028

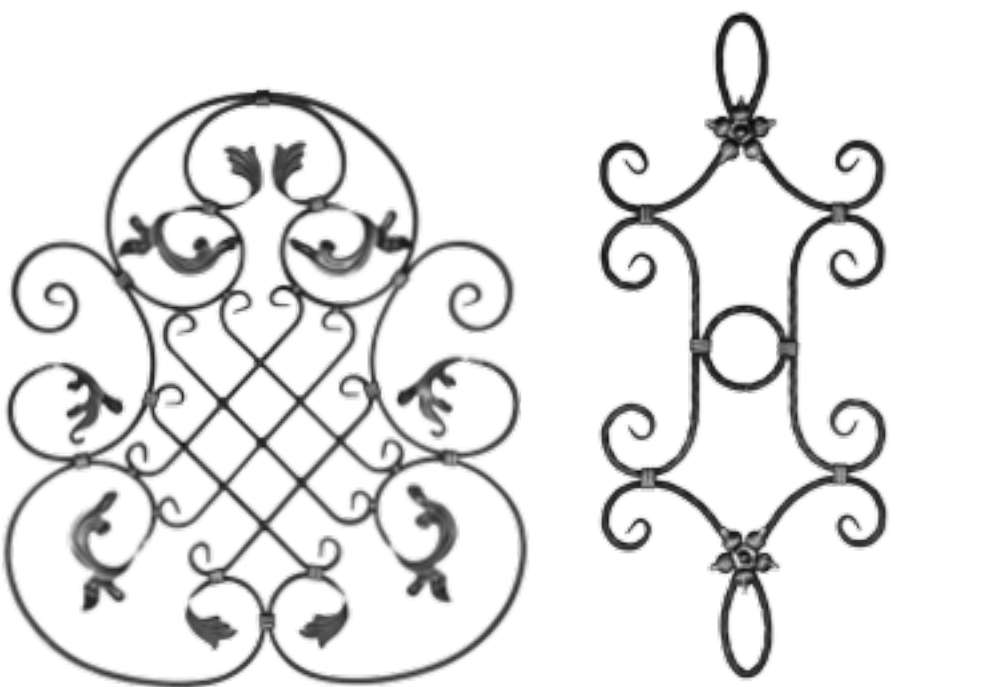

□	16x8	12x12
H	800	900
L	700	385
N°	13.029	13.030

ORNAMENTY

rosettes / розетки / Rosetten



□	12x12	12x12	12x12
H	560	600	510
L	400	370	690
N°	13.032	13.033	13.034



□	12x12	12x12	12x12
H	480	480	450
L	320	250	340
N°	13.035	13.036	13.037



□	12x12	12x12	12x12
H	500	400	400
L	250	350	300
N°	13.038	13.040	13.041

ORNAMENTY

rosettes / розетки / Rosetten

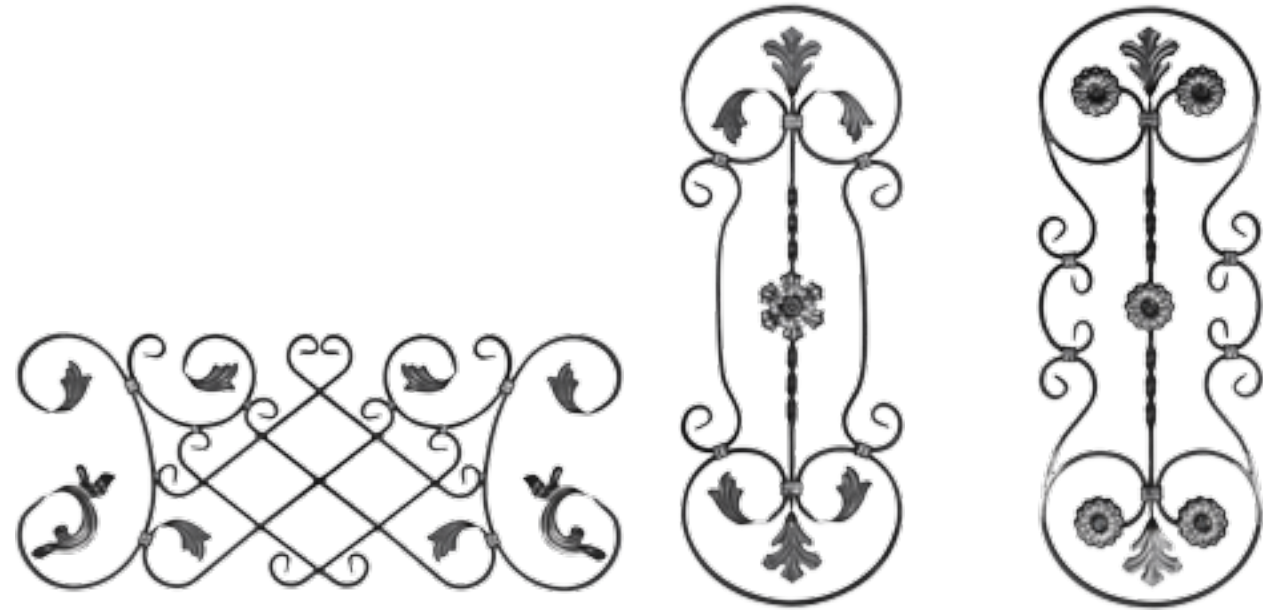
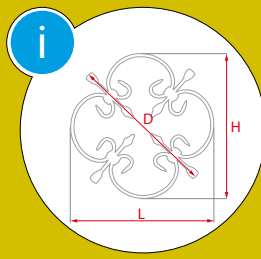

□	16x8	16x8	16x8
H	370	800	800
L	880	300	300
N°	13.042	13.045	13.046

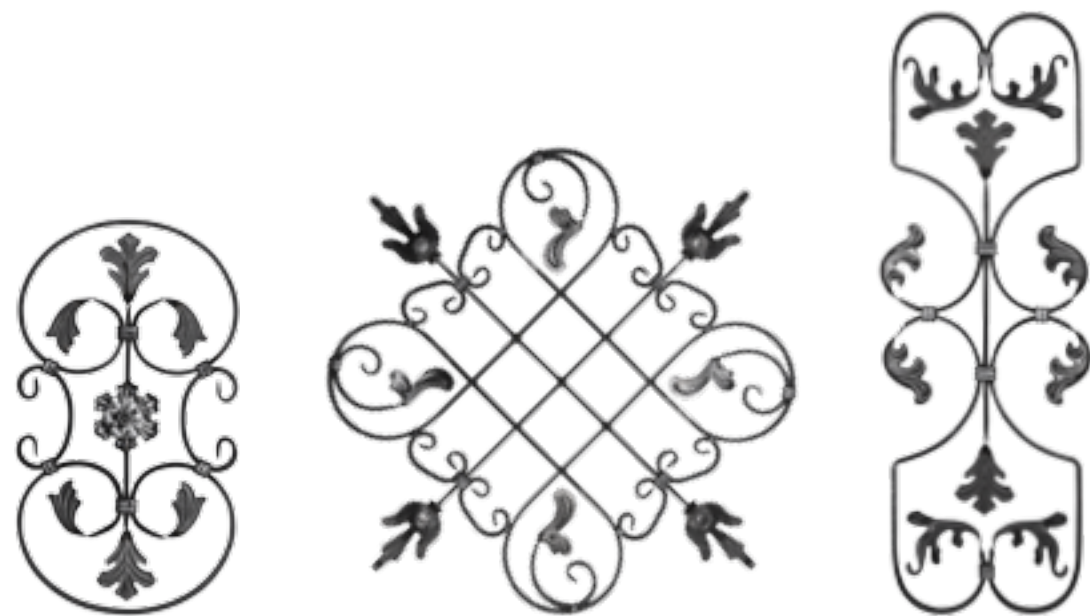

□	16x8	16x8	16x8
H	530	780	800
L	300	780	270
D		870	
N°	13.048	13.056	13.057

ORNAMENTY

rosettes / розетки / Rosetten

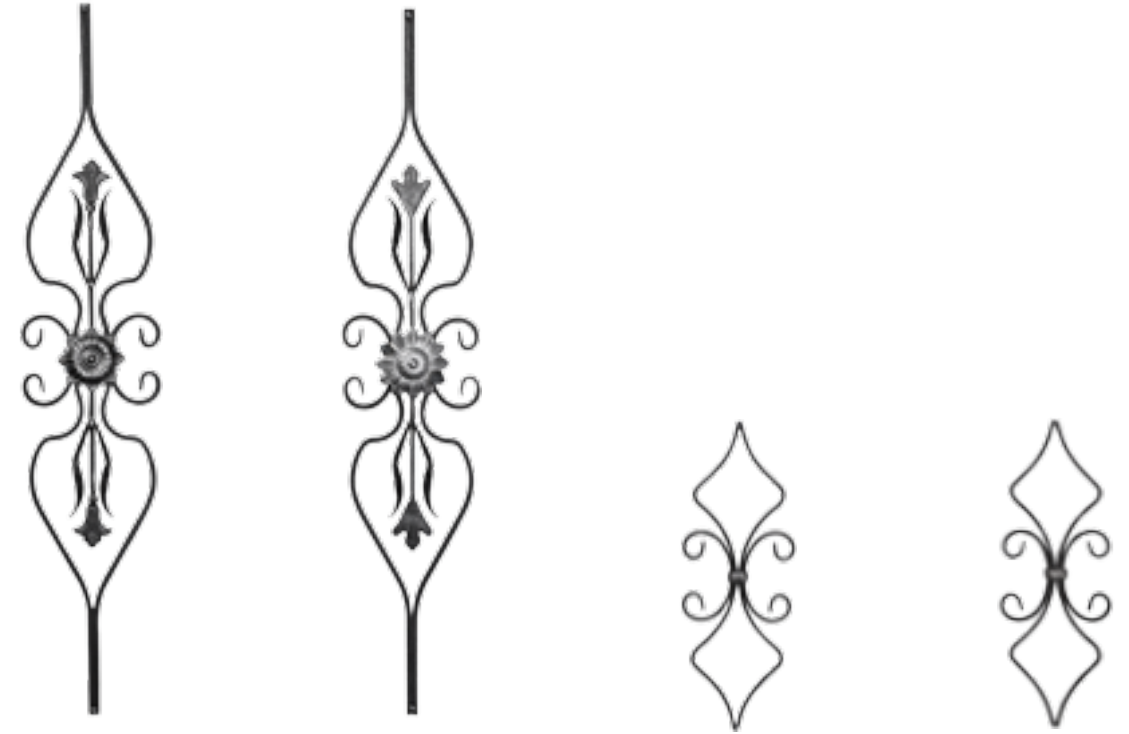

□	16x8	16x8	10x5	12x6
H	950	950	410	410
L	180	180	165	165
N°	13.058	13.059	13.060	13.061



□	12x6	12x16
H	230	250
L	700	700
N°	13.067	13.068



ORNAMENTY

rosettes / розетки / Rosetten

□	12x6
H	250
L	1200
N°	13.070



□	16x8
H	400
L	1510
N°	13.071



□	16x8
H	400
L	1510
N°	13.072



□	16x8
H	330
L	1270
N°	13.073



□	16x8
H	330
L	1270
N°	13.074



ORNAMENTY

rosettes / розетки / Rosetten

□	16x8
H	170
L	970
N°	13.090



□	16x8
H	135
L	950
N°	13.091



□	∅12
H	170
L	970
N°	13.092



≠	4
H	100
L	1160
N°	13.093



≠	4
H	100
L	1170
N°	13.094



≠	4
H	90
L	1195
N°	13.096



≠	4
H	120
L	1183
N°	13.097

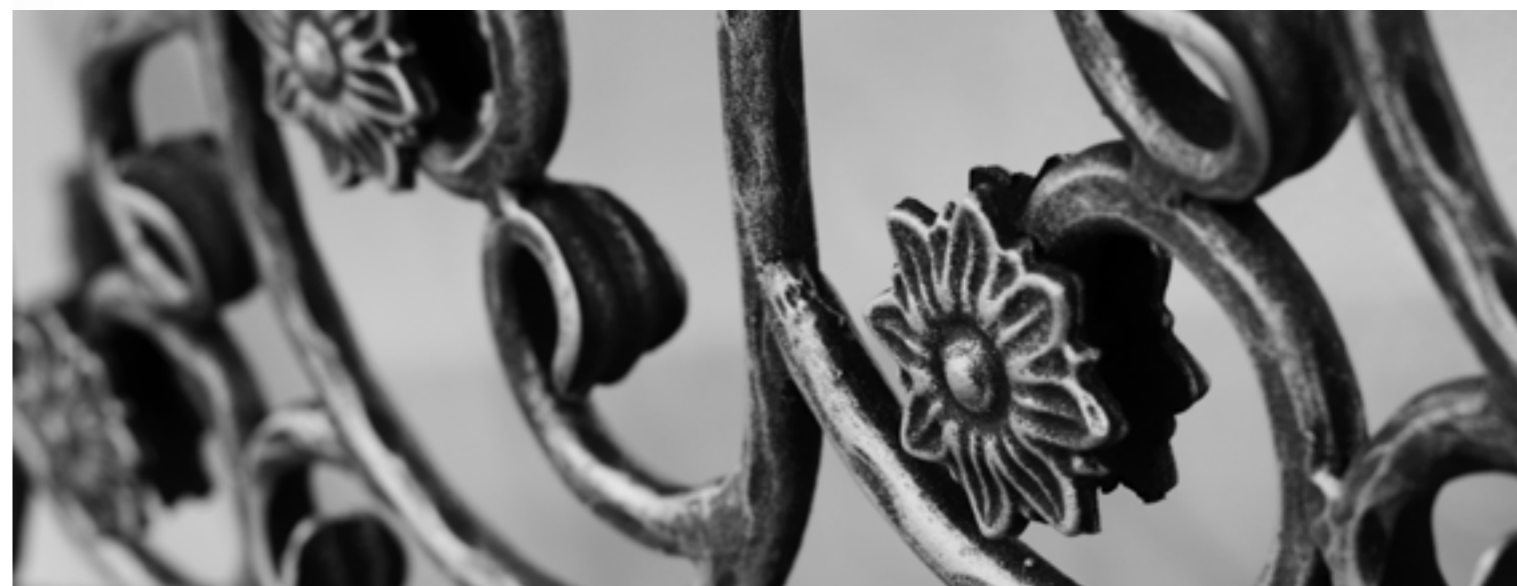

ORNAMENTY

rosettes / розетки / Rosetten



□	ø11
H	950
L	500
N°	13.081

□	ø11
H	940
L	500
N°	13.082



□	ø12
H	1080
L	750
N°	13.100

□	ø12
H	1080
L	750
N°	13.101

ORNAMENTY

rosettes / розетки / Rosetten



□	ø12
H	880
L	750
N°	13.104

□	ø12
H	880
L	750
N°	13.105



□	ø12
H	880
L	500
N°	13.106

□	ø12
H	880
L	500
N°	13.107

ORNAMENTY

rosettes / розетки / Rosetten



□	16x8	16x8	16x8
H	800	800	740
L	300	300	320
N°	13.111	13.112	13.113



□	16x8	16x8
H	610	400
L	700	800
N°	13.190	13.191

ORNAMENTY

rosettes / розетки / Rosetten



□	16x8
H	400
L	1000
N°	13.192



□	16x8
H	600
L	1580
N°	13.198

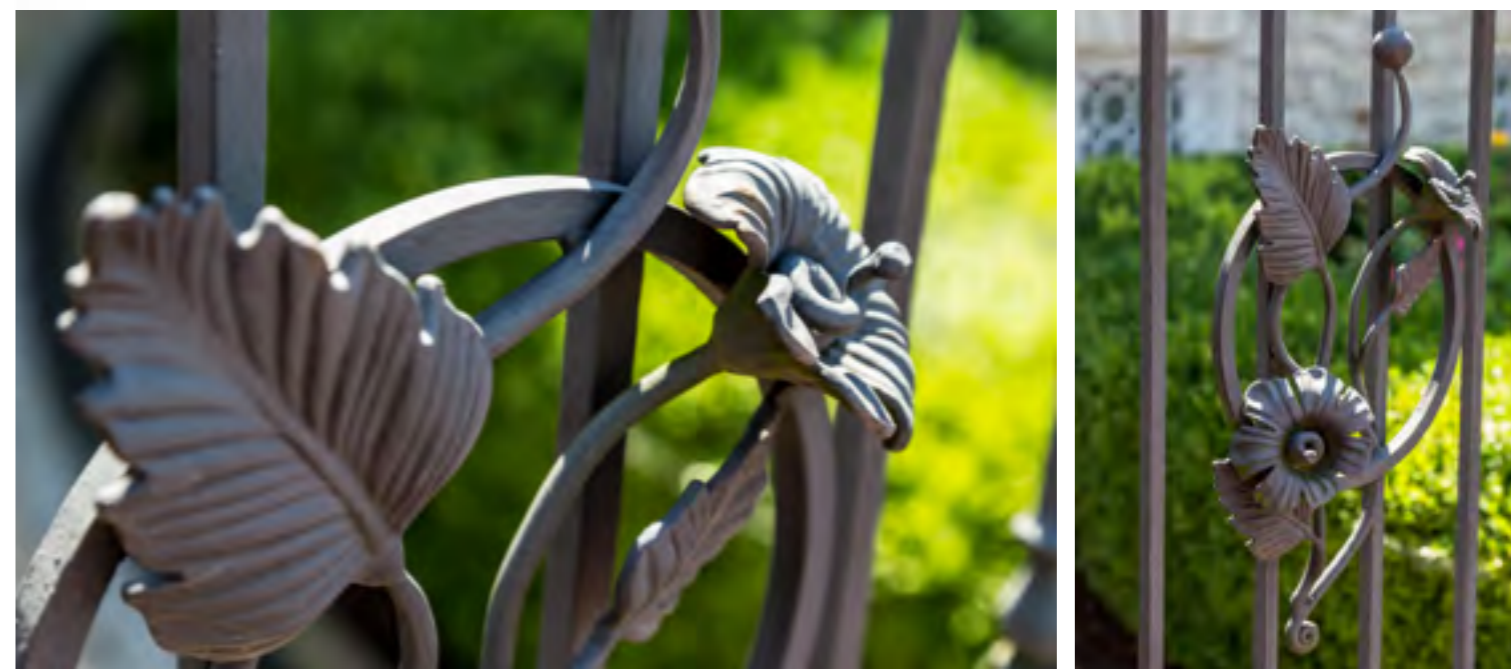

ORNAMENTY

rosettes / розетки / Rosetten



□	ø16, ø14, ø12
H	800
L	2000
N°	13.200

ORNAMENTY

rosettes / розетки / Rosetten



□	ø12	ø12	ø12	ø12
H	860	860	430	430
L	950	950	190	190
N°	13.209	13.210	50.175	50.176



□	ø14	ø14	ø14
H	800	1000	800
L	160	215	165
N°	13.202	13.203	13.204

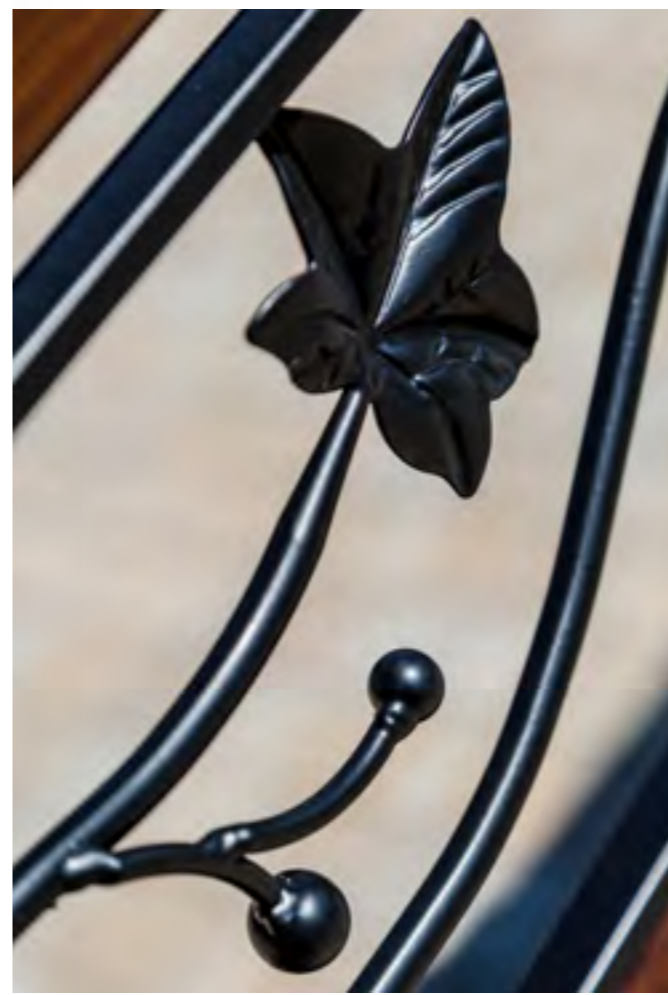

ORNAMENTY

rosettes / розетки / Rosetten

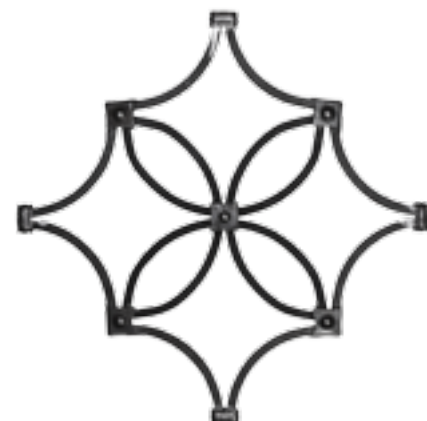

□	12x12	12x12	12x12
H	540	560	516
L	380	400	516
N°	13.240	13.241	13.244



□	12x12	12x12	12x12
H	460	430	ø384
L	ø385	ø250	
N°	13.248	13.249	13.250



□	12x12	12x12	12x12
H	525	440	545
L	ø250	ø400	ø385
N°	13.251	13.252	13.253

ORNAMENTY

rosettes / розетки / Rosetten



□	12x12		
H	440	660	530
L	250	470	490
N°	13.256	13.302	13.303



□		12x12	12x12
H	405	450	500
L	405	370	384
N°	13.308	13.315	13.323



TYČE A SLOUPKY

balusters and baluster posts / балясины / Stäbe und Brüstungspfosten



□ 12x12	12x12	12x12
L 160	175	200
H 950	950	950
N° 20.001	20.003	20.010

□ 12x12	12x12	14x14
L 200	200	200
H 950	950	950
N° 20.010.01	20.011	20.012

□ 14x14	12x12
L 200	190
H 950	950
N° 20.013	20.020

TYČE A SLOUPKY

balusters and baluster posts / балясины / Stäbe und Brüstungspfosten

□ 12x12	12x12	12x12	30x5
L 200	230	230	170
H 950	950	950	800
N° 20.100	20.102	20.105	20.130

□ 50x10	16x16	12x12	12x12
L 185	225	950	950
H 850	950	950	950
N° 20.148	20.149	21.010	21.011

□ 12x12	12x12	12x6	12x12
L 950	950	350	90
H 950	950	860	950
N° 21.024	21.025	21.116	21.117



TYČE A SLOUPKY

balusters and baluster posts / балясины / Stäbe und Brüstungspfosten



□	16x8	12x12	12x12
L	155	270	170
H	950	950	950
N°	21.118	21.119	21.120

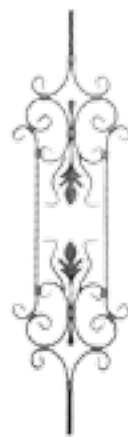

□	16x8	12x12	12x12
L	165	240	200
H	950	950	950
N°	21.122	21.124	21.140



□	12X12	12X12	12X12
L	275	195	200
H	950	950	950
N°	21.141	21.145	21.147



TYČE A SLOUPKY

balusters and baluster posts / балясины / Stäbe und Brüstungspfosten



□	ø30 x 1,5	ø30 x 1,5	ø30 x 1,5
H	900	900	900
N°	21.900	21.901	21.902



□	ø14	ø14	12x12	12x12
L	36	36	30	30
H	950	950	950	950
N°	22.001	22.002	22.003	22.004



□	12x12	12x12	12x12	12x12
L	35	30	36	36
H	950	950	950	950
N°	22.005	22.013	22.019	22.020



TYČE A SLOUPKY

balusters and baluster posts / балясины / Stäbe und Brüstungspfosten



□	∅12	∅12	∅12
L	24	24	50
H	950	950	1000
N°	22.021	22.022	22.053

□	12x12	12x12	12x12
L	140	185	180
H	950	950	950
N°	22.100	22.103	22.104

□	12x12	12x12
L	180	160
H	950	950
N°	22.105	22.107

TYČE A SLOUPKY

balusters and baluster posts / балясины / Stäbe und Brüstungspfosten

□	∅12	∅12	14x14	14x14
L	25	25	30	30
H	950	950	950	950
N°	23.001	23.002	23.003	23.004

□	∅12	∅12	12x12	12x12
L	25	25	30	30
H	950	950	950	950
N°	23.005	23.006	23.007	23.008

□	14x14	14x14	14x14	∅12	∅12
L	35	35	65	40	40
H	950	950	950	950	950
N°	23.009	23.010	23.015	23.020	23.021

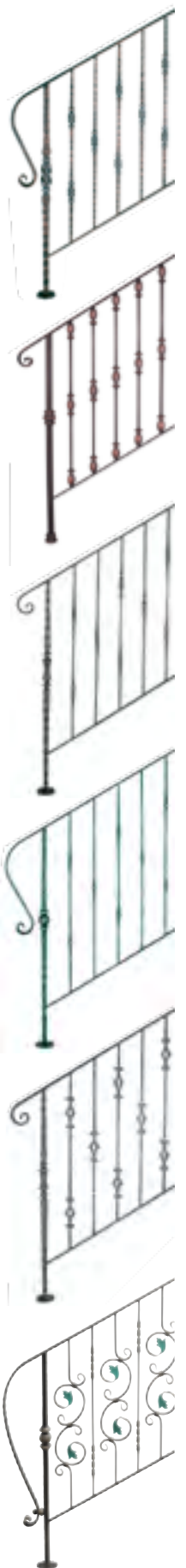

TYČE A SLOUPKY

balusters and baluster posts / балясины / Stäbe und Brüstungspfosten



□	14x14	14x14	16x16
L	35	40	60
H	950	950	950
N°	23.024	23.025	23.065



□	20x20	∅25	∅28
L	80	55	60
H	1 200	1 200	1 200
N°	24.011	24.111	24.112

TYČE A SLOUPKY

balusters and baluster posts / балясины / Stäbe und Brüstungspfosten



□	25x27	25x25	25x25
L	100	50	34
H	1 200	1 200	1 200
N°	24.151	24.254	24.255



□	25x25	25x25	25x25
L	48	50	66
H	1 200	1 200	1 200
N°	24.257	24.259	24.266



MADLA A VOLUTY

flat bars and banding materials / полосы и ленты / Flacheisen und Hespeneisen



H	100		180			
L	3000	6000	350	680	300	400
□	40x12	40x12	40x12			40x12
N°	30.001	30.001.00	30.001.01			30.001.04
□	50x14	50x14	50x14	50x14	50x14	
N°	30.002	30.002.00	30.002.01	30.002.02	30.002.03	
□	40x10	40x10	40x10	40x10	40x10	40x10
N°	30.003	30.003.00	30.003.01	30.003.02	30.003.03	30.003.04



MADLA A VOLUTY

flat bars and banding materials / полосы и ленты / Flacheisen und Hespeneisen

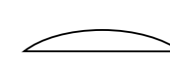

H	100				
L	3000	6000	3000	6000	350
□	40x8	40x8	40x8	40x8	40x8
N°	30.008	30.008.00	30.010	30.010.00	30.010.01

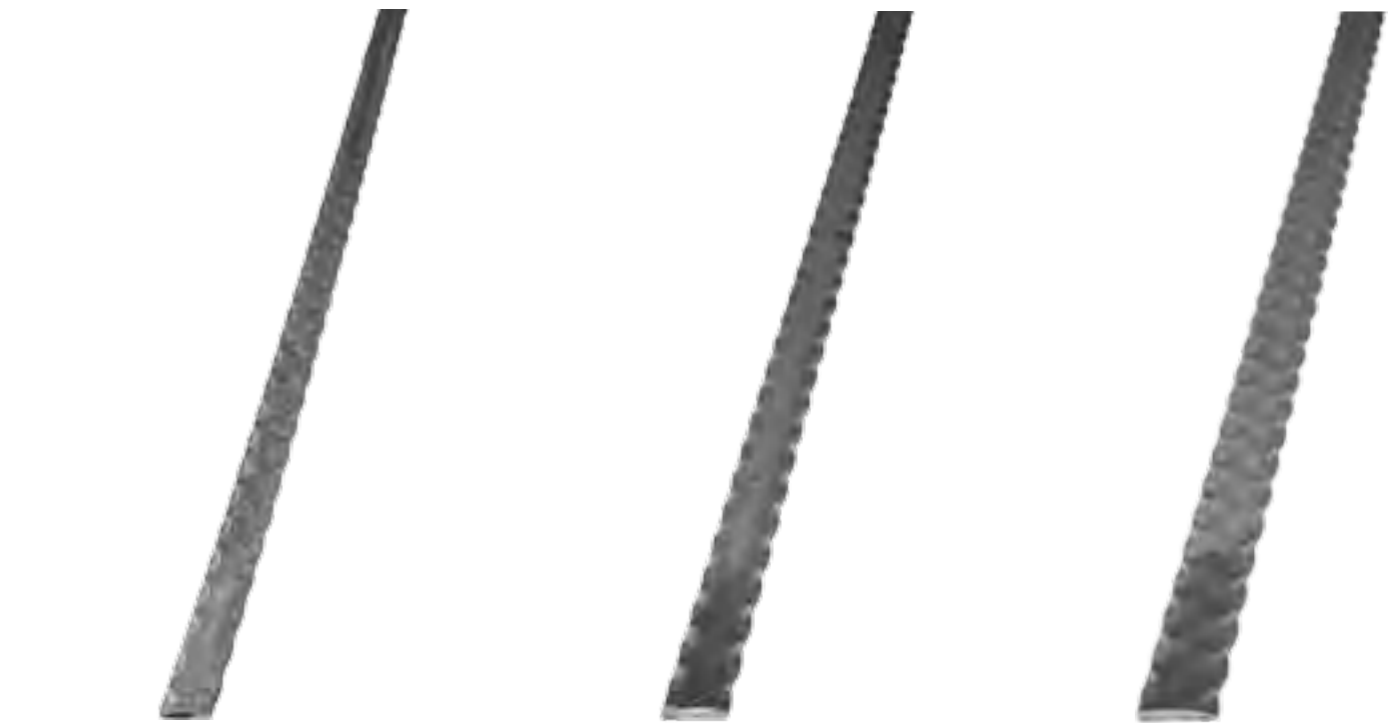

L	3000	6000	3000	6000	3000	6000
□	20x5	20x5	25x5	25x5	30x5	30x5
N°	30.100	30.100.00	30.101	30.101.00	30.102	30.102.00

MADLA A VOLUTY

flat bars and banding materials / полосы и ленты / Stangenmaterial und Hespeneisen



H	100			
L	3000	6000	350	680

□	40x8	40x8	40x8
N°	30.103	30.103.00	30.003.01

□	40x5	40x5	40x5	40x5
N°	30.105	30.105.00	30.105.01	30.105.02

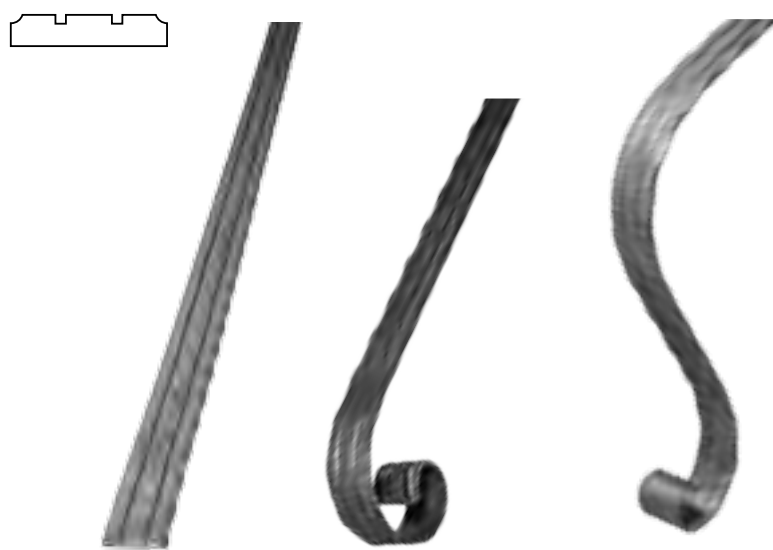

H	100			
L	3000	6000	350	400

□	40x5	40x5	40x5	40x5
N°	30.113	30.113.00	30.113.01	30.113.04

□	40x8	40x8	
N°	30.123	30.123.00	

MADLA A VOLUTY

flat bars and banding materials / полосы и ленты / Stangenmaterial und Hespeneisen

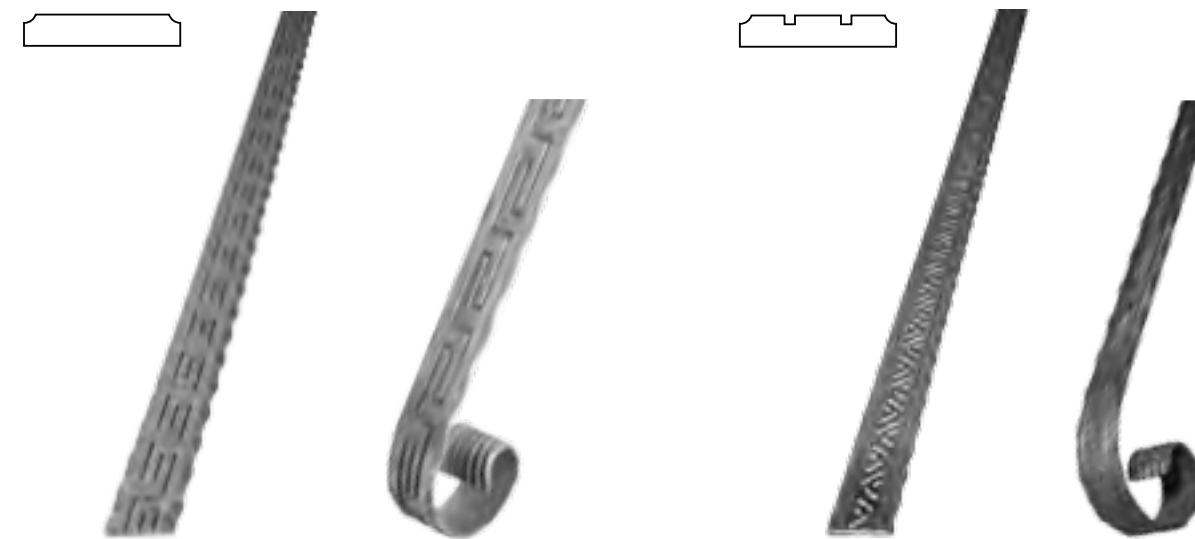

H	100			100		
L	3000	6000	350	3000	6000	350

□	40x5	40x5	40x5	40x5	40x5	40x5
N°	30.111	30.111.00	30.111.01	30.114	30.114.00	30.114.01

□	40x8	40x8		40x8	40x8	
N°	30.121	30.121.00		30.124	30.124.00	



MADLA A VOLUTY

flat bars and banding materials / полосы и ленты / Stangenmaterial und Hespeneisen

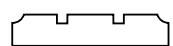

L	3000	6000
---	------	------

□	40x5	40x5
N°	30.115	30.115.00

□	40x8	40x8
N°	30.125	30.125.00

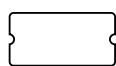

L	3000
---	------

□	16x8
N°	30.220

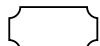

L	3000	3000
---	------	------

□	12x6	20x10
N°	30.200	30.202

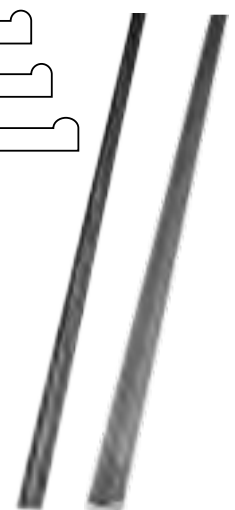
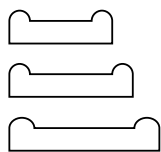

L	3000	6000
---	------	------

□	25x8	25x8
N°	31.101	31.101.00

□	30x8	30x8
N°	31.102	31.102.00

□	40x8	40x8
N°	31.103	31.103.00

MADLA A VOLUTY

flat bars and banding materials / полосы и ленты / Stangenmaterial und Hespeneisen

měkká (sponkovina)
soft and flexible / мягкий и гибкий / weich und flexibel

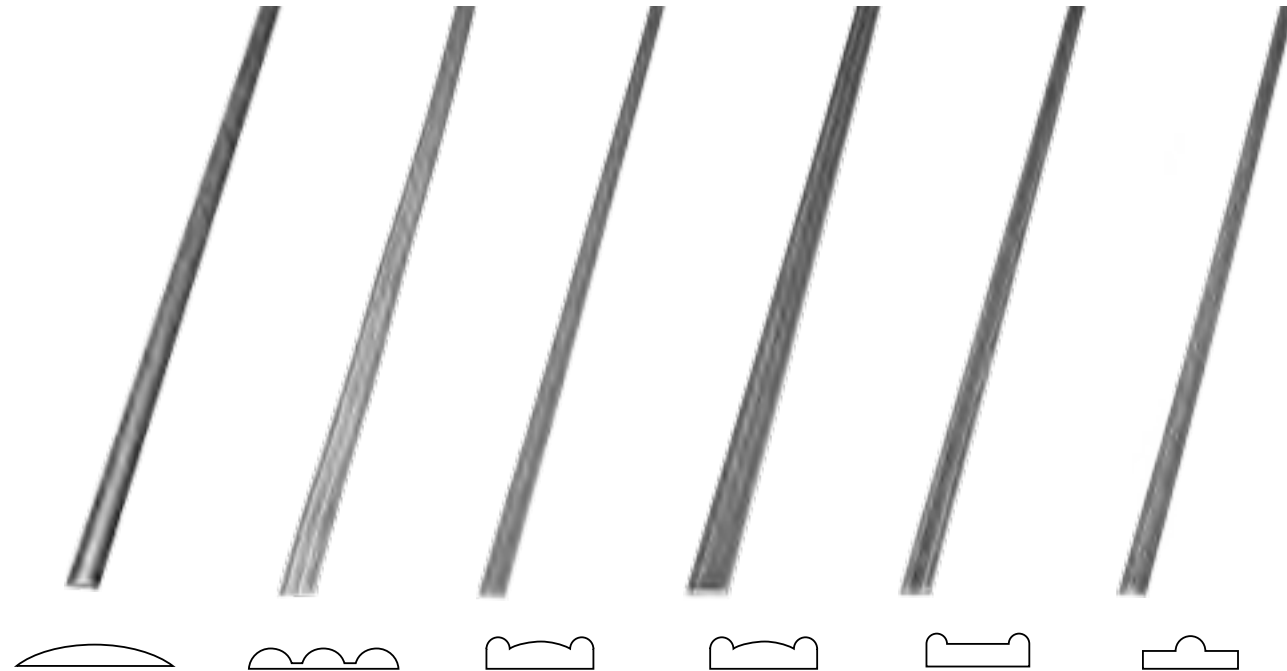

L	3000	2000	3000	3000	3000	3000
□	14x4	18x1,5	14x3	20x4	14x4	14x4
N°	31.300.01	31.350	31.400	31.402	31.403	31.404

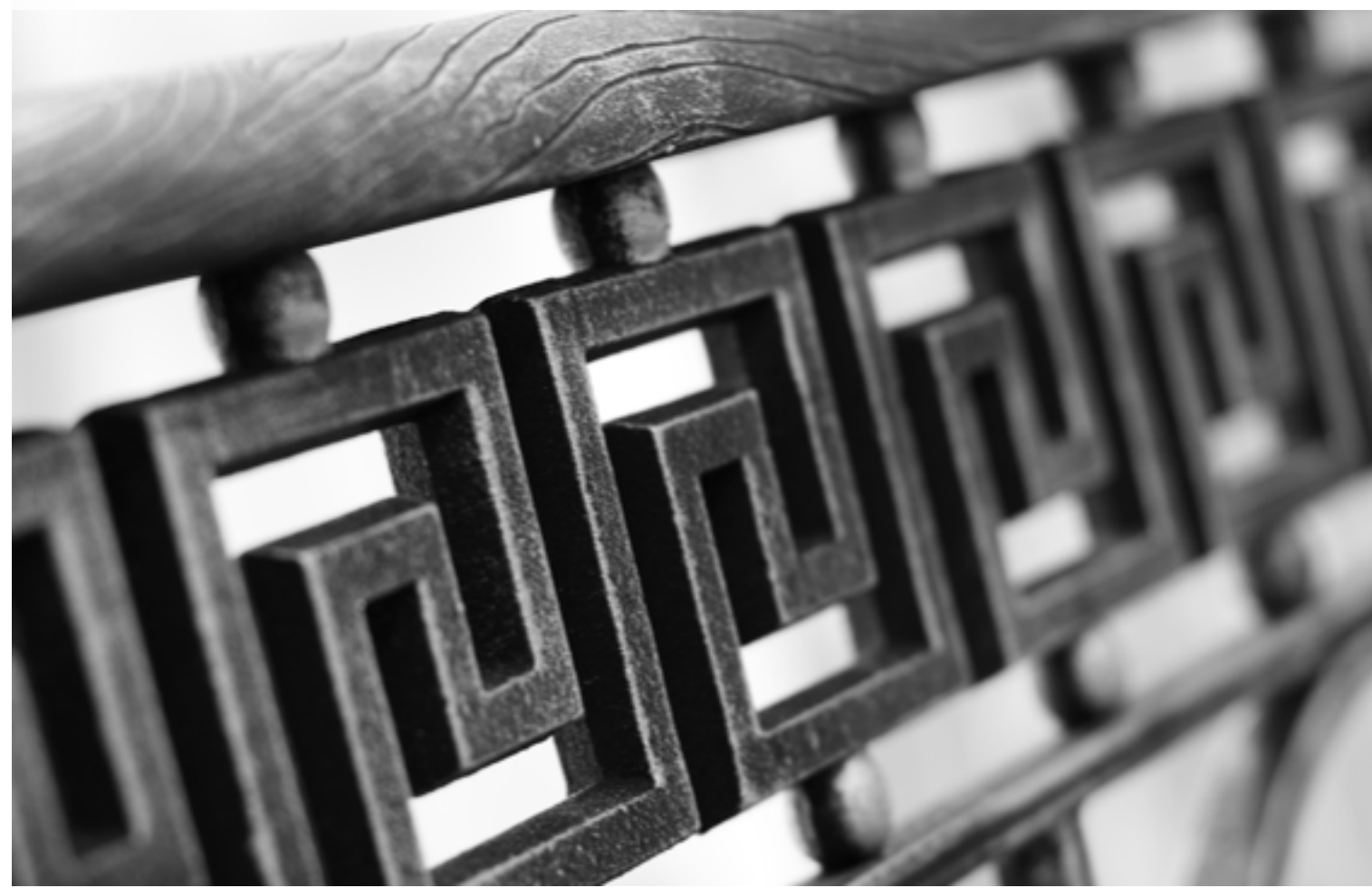

ZDOBENÉ A PROBÍJENÉ TYČE, ZDOBENÉ PROFILY

bars and decorative bars / прутья и декоративные прутья /
Vierkantrohre und decorative Stäbe



□	48x20	48x20	48x20	62x30	62x30	32x30
≠	1,5	1,5	1,5	1,5	1,5	1,5
L	3000	3000	3000	3000	3000	3000
N°	30.020	30.020.01	30.020.02	30.021	30.021.01	30.021.02



□	54x54	54x54	54x54	□	48x20	62x30	54x54
≠	1,5	1,5	1,5	H	40	50	36
L	3000	3000	3000	N°	30.030	30.031	30.032
N°	30.022	30.022.01	30.022.02				

ZDOBENÉ A PROBÍJENÉ TYČE, ZDOBENÉ PROFILY

bars and decorative bars / прутья и декоративные прутья /
Vierkantrohre und decorative Stäbe



□	L	N°
12x12	3000	32.001
12x12	6000	32.001.00
14x14	3000	32.003
14x14	6000	32.003.00
16x16	3000	32.005
16x16	6000	32.005.00
20x20	3000	32.007



□	L	N°
∅10-12	1100	32.100
∅12-16	1100	32.101

ZDOBENÉ A PROBÍJENÉ TYČE, ZDOBENÉ PROFILY

bars and decorative bars / прутья и декоративные прутья /
Vierkantrohre und decorative Stäbe



□	L	N°
∅8	3000	32.111
∅8	6000	32.111.00
∅10	3000	32.112
∅10	6000	32.112.00
∅12	3000	32.113
∅12	6000	32.113.00
∅14	3000	32.114
∅14	6000	32.114.00
∅16	3000	32.115
∅16	6000	32.115.00
∅20	3000	32.117
∅20	6000	32.117.00



□	L	N°
∅20	2750	32.200
∅30	2750	32.201
∅38	2750	32.202

ZDOBENÉ A PROBÍJENÉ TYČE, ZDOBENÉ PROFILY

bars and decorative bars / прутья и декоративные прутья /
Vierkantrohre und decorative Stäbe

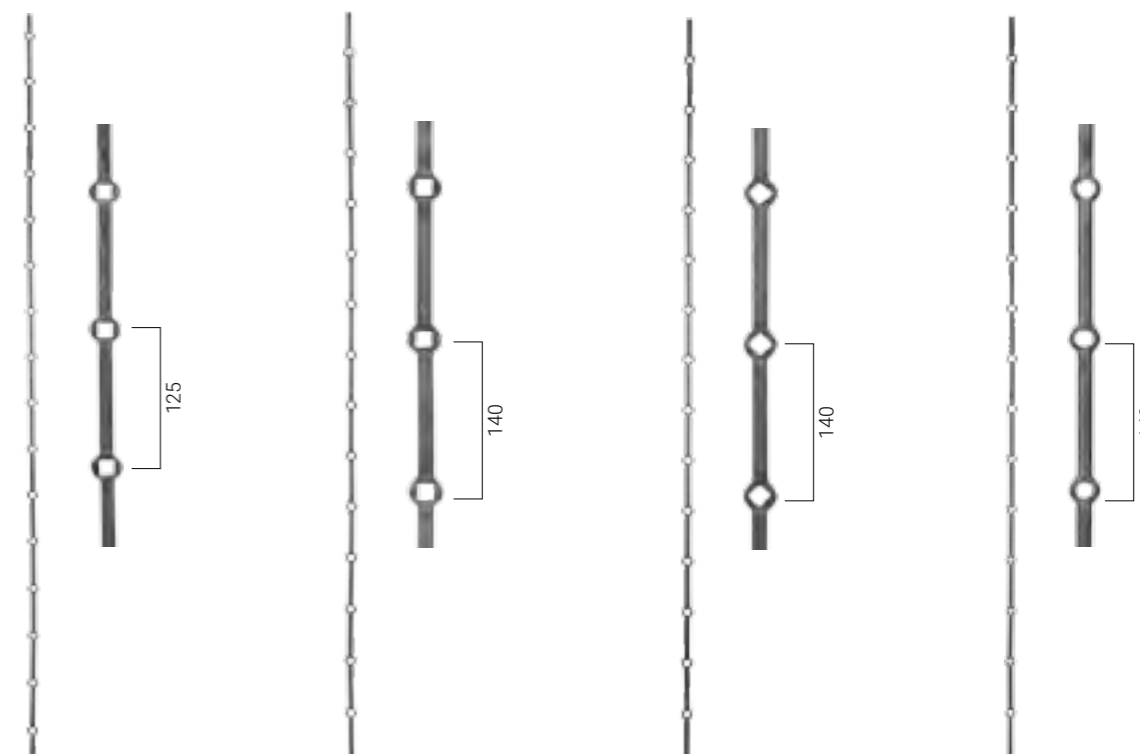
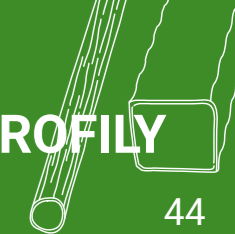

□	12x12	14x14	14x14	14
H	2000	2000	2000	2000
N°	33.000	33.001	33.013	33.023

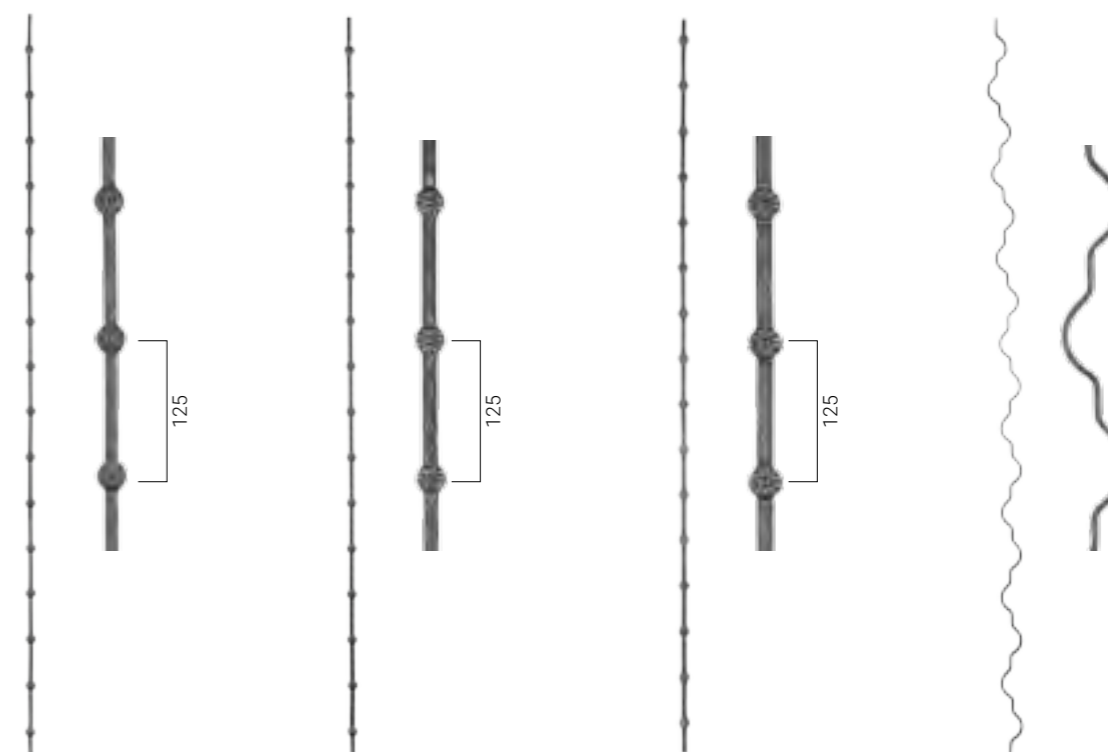

□	12x12	12x12	14x14	12x6
H	2000	2000	2000	2000 x 65
N°	33.098	33.099	33.100	33.201

ZDOBENÉ A PROBÍJENÉ TYČE, ZDOBENÉ PROFILY

bars and decorative bars / прутья и декоративные прутья /
Vierkantrohre und decorative Stäbe



□	≠	L	N°
15x15	1,5	3000	34.000
15x15	1,5	6000	34.000.00
20x20	2	3000	34.002
20x20	2	6000	34.002.00
25x25	2	3000	34.005
25x25	2	6000	34.005.00
30x30	2	3000	34.008
30x30	2	6000	34.008.00
40x40	2,5	3000	34.011
40x40	2,5	6000	34.011.00
50x50	3	3000	34.014
50x50	3	6000	34.014.00
60x60	3	3000	34.017
60x60	3	6000	34.017.00
80x80	3	3000	34.020
80x80	3	6000	34.020.00
100x100	3	3000	34.023
100x100	3	6000	34.023.00

ZDOBENÉ A PROBÍJENÉ TYČE, ZDOBENÉ PROFILY

bars and decorative bars / прутья и декоративные прутья /
Vierkantrohre und decorative Stäbe



□	≠	L	N°
30x20	2	3000	34.102
30x20	2	6000	34.102.00
40x20	2	3000	34.105
40x20	2	6000	34.105.00
40x30	2	3000	34.107
40x30	2	6000	34.107.00
50x30	3	3000	34.111
50x30	3	6000	34.111.00
60x40	3	3000	34.120
60x40	3	6000	34.120.00



□	≠	L	N°
∅30	1,2	3000	34.221
∅40	1,2	3000	34.230
∅50	1,5	3000	34.231

HROTY

spearheads / пики / Spitzen



□	∅15	∅16	∅24	∅25	∅30
H	150	150	160	110	125
L	55	66	63	55	65
N°	40.001	40.002	40.003	40.006	40.007

HROTY

spearheads / пики / Spitzen



□	∅13	∅13	∅20	∅26	∅20
H	125	130	110	135	130
L	60	53	60	70	70
N°	40.041	40.045	40.048	40.049	40.050



□	∅18	∅12	∅15	∅12	∅24	∅25
H	110	100	125	140	128	140
L	48	45	55	110	65	70
N°	40.008	40.011	40.012	40.013	40.017	40.018



□	∅12	∅12	12X12	∅17	∅20	∅25
H	130	130	115	155	80	125
L	60	60	53	70	45	65
N°	40.052	40.052.02	40.052.03	40.053	40.055	40.056



HROTY

spearheads / пики / Spitzen



□	ø20	ø25	ø20	ø16	ø20	ø26
H	120	135	115	82	115	140
L	55	65	58	40	58	70
N°	40.058	40.059	40.060	40.060.01	40.060.02	40.061



□	12X12	14X14	12X12	14X14
H	120	140	150	180
L	42	47	40	43
N°	40.065	40.066	40.067	40.068

HROTY

spearheads / пики / Spitzen



□	ø25	ø20	ø25	ø20	ø30
H	125	95	135	98	160
L	40	30	40	33	50
N°	40.071	40.071.01	40.072	40.072.01	40.073



□	ø32	ø25	15X15	15X15	12X12
H	125	110	140	130	120
L	60	50	58	50	43
N°	40.077	40.077.02	40.078	40.078.01	40.078.02



□	ø16	ø16	ø25
H	155	160	125
L	65	65	45
N°	40.080	40.081	40.083

HROTY

spearheads / пики / Spitzen



□	20x20	25x25	20x20	15x15	32x32
H	100	160	125	82	160
L	20	25	30	20	40
N°	40.088.01	40.089	40.092	40.092.01	40.093



□	12x12	18	24x24	24x24	33	30	∅24
H	95	125	60	60	150	120	88
L	27	40	35	30	40	35	28
N°	40.095	40.096	40.097	40.097.30	40.098.01	40.098.02	40.098.03



□	25x25	30x30	40x40	18x21	∅16
H	120	155	200	105	160
L	67	92	117	53	90
N°	40.099.01	40.099.02	40.099.03	40.099.04	40.100

HROTY

spearheads / пики / Spitzen



□	∅13	14x14	∅16	15x15	18x18	26x26
H	140	110	160	145	250	290
L	50	50	65	80	80	75
N°	40.102	40.102.01	40.104	40.106	40.110	40.111

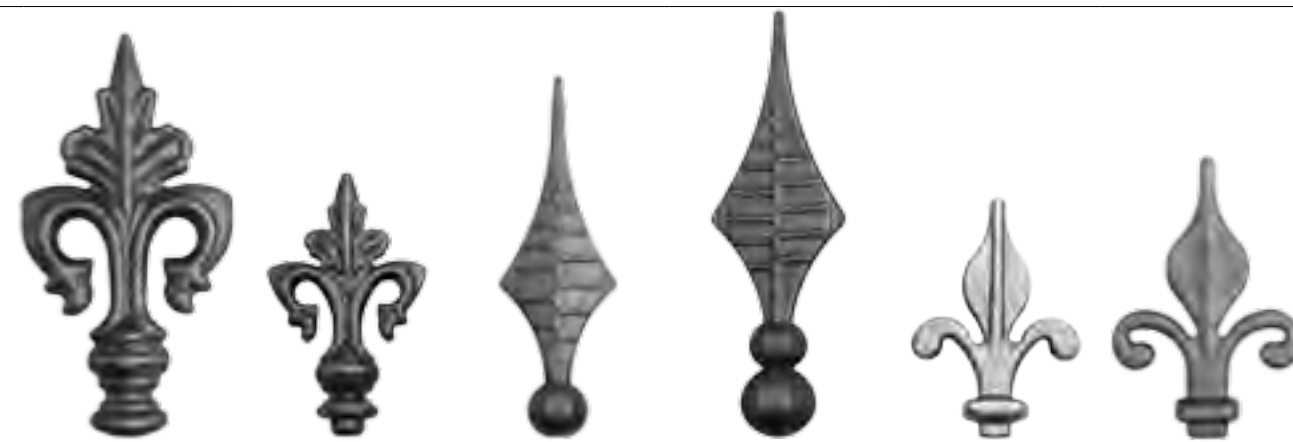

□	∅40	∅16	∅29	∅35	12x12	20x20
H	200	120	180	205	90	135
L	100	73	60	65	63	90
N°	40.112	40.112.01	40.117	40.118	40.123	40.125

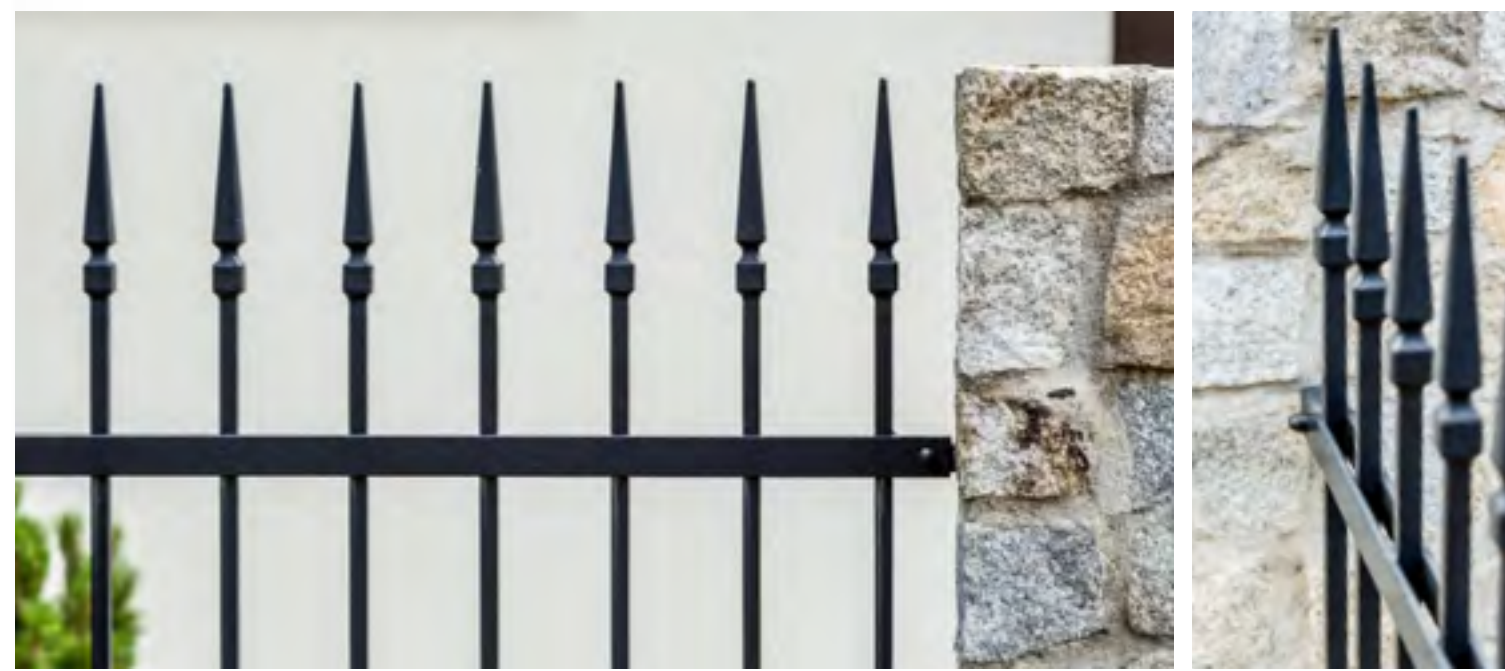

HROTY

spearheads / пики / Spitzen



□	ø33	12x12	14x14	16x16	ø12	12x12
H	130	150	150	57	92	120
L	47	30	30	38	35	35
N°	40.126	40.133	40.138	40.140	40.150	40.151



□	16x16	16x16	20x20	ø16	ø26	36
H	107	142	148	132	134	145
L	25	28	35	85	64	36
N°	40.153	40.154	40.155	40.156	40.157	40.159

HROTY

spearheads / пики / Spitzen



□	16x16	12x12	12x12	14x14	16x16	12x12
H	105	200	250	250	155	160
L	60				60	50
N°	40.162	40.170	40.180	40.181	40.182	40.183



□	ø22	15x15	18x18	
H	80	82	110	240
L	22	15	18	110
N°	40.200	40.210	40.211	40.300





□	12,5 x 12,5	12,5 x 12,5	
H	39	67	67
L	40	40	40
N°	41.001	41.002	41.002.01



□	14,5 x 14,5	14,5 x 14,5	∅14,5	∅14,5
H	44	67	40	67
L	45	45	39	40
N°	41.003	41.004	41.005	41.006



□	16,5x16,5	16,5x16,5	∅16,5	∅16,5
H	44	67	44	67
L	45	45	45	45
N°	41.007	41.008	41.011	41.012



□	12,5 x 12,5	12,5 x 12,5	14,5 x 14,5	14,5 x 14,5	16,5 x 16,5	16,5 x 16,5
H	40	65	40	65	40	65
L	38	38	38	38	38	38
N°	41.021	41.022	41.023	41.024	41.025	41.026



□	∅30
H	80
L	69
N°	41.050



□	30,5 x 30,5
H	80
L	69
N°	41.060



□	27x27
H	215
L	63
N°	41.070

NÁVLEKY

ornamental steel collars/ насадки / Zierhülsen



□	12,5x 12,5	14,5x 14,5	16,5x16,5	21,5x21,5	∅12	∅14,5	∅16,5
H	22	22	22	25	25	22	22
L	40	40	40	45	35	40	40
N°	41.102	41.104	41.105	41.106	41.111	41.114	41.115



□	12,5x12,5	14,5x14,5	16,5x16,5	20,5x20,5	25,5x25,5
H	22	22	22	35	35
L	33	38	38	55	55
N°	41.202	41.204	41.205	41.206	41.207



NÁVLEKY

ornamental steel collars/ насадки / Zierhülsen



□	14,5x14,5	14,5x14,5
H	70	130
L	35	35
N°	41.306	41.307



□	16x16	16x16
H	75	148
L	42	48
N°	41.315	41.316



□	∅16	∅16
H	75	125
L	38	38
N°	41.317	41.318



NÁVLEKY

ornamental steel collars/ насадки / Zierhülsen



□	∅12	12x12	12x12
H	140	140	160
L	28	26	25
N°	41.400	41.401	41.402



□	14x14	12 - 14	16 - 20	20 - 30
H	80	70	75	150
L	35	30	35	35
N°	41.403	41.407	41.408	41.409

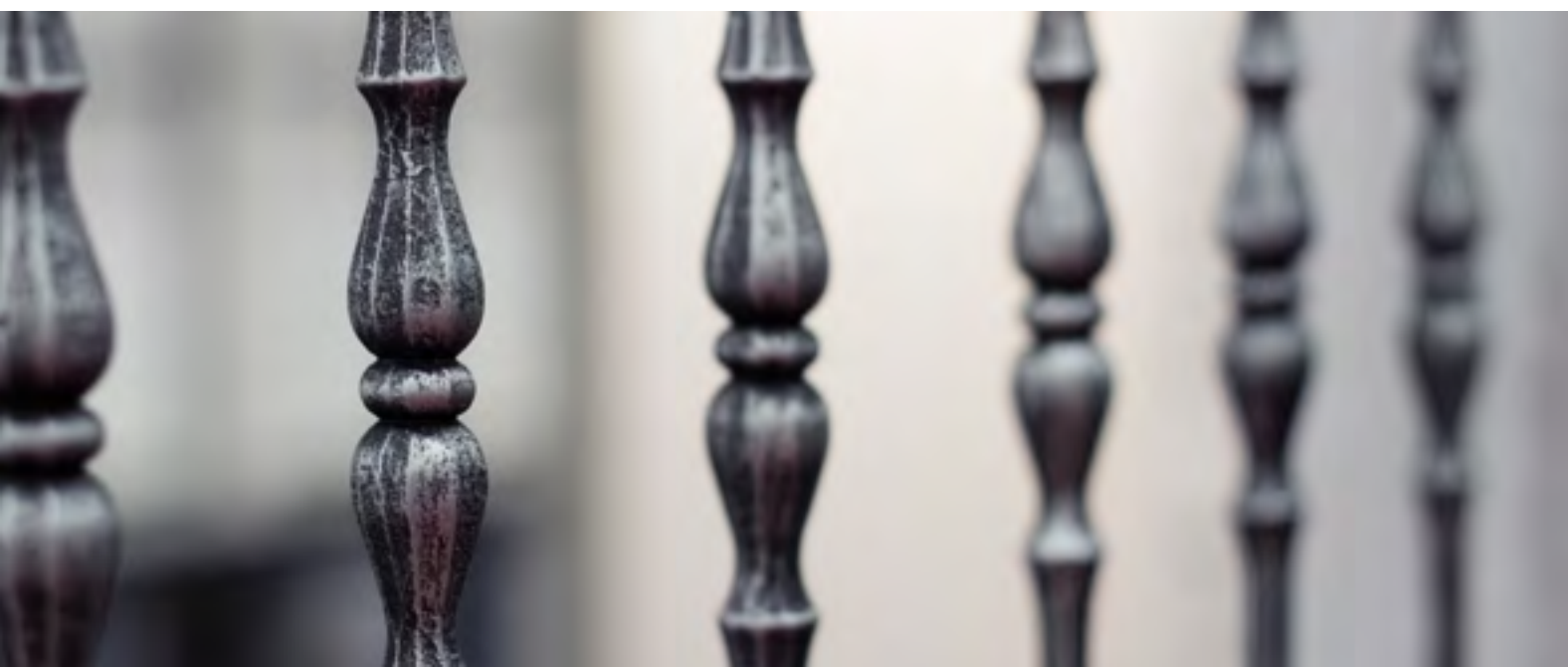

NÁVLEKY

ornamental steel collars/ насадки / Zierhülsen

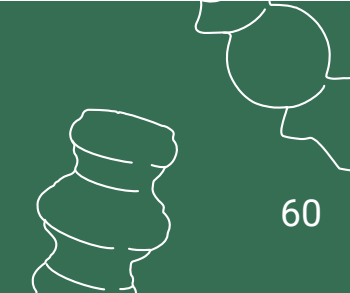

tenkostěnné
thin-walled / тонкостенные / dünnwandig



□	12,5 x 12,5	12,5 x 12,5
H	39	67
L	40	40
N°	41.501	41.502

tenkostěnné
thin-walled / тонкостенные / dünnwandig



□	14,5 x 14,5	14,5 x 14,5
H	40	67
L	45	45
N°	41.503	41.504

tenkostěnné
thin-walled / тонкостенные / dünnwandig



□	∅14,5	∅14,5
H	39	67
L	40	40
N°	41.505	41.506

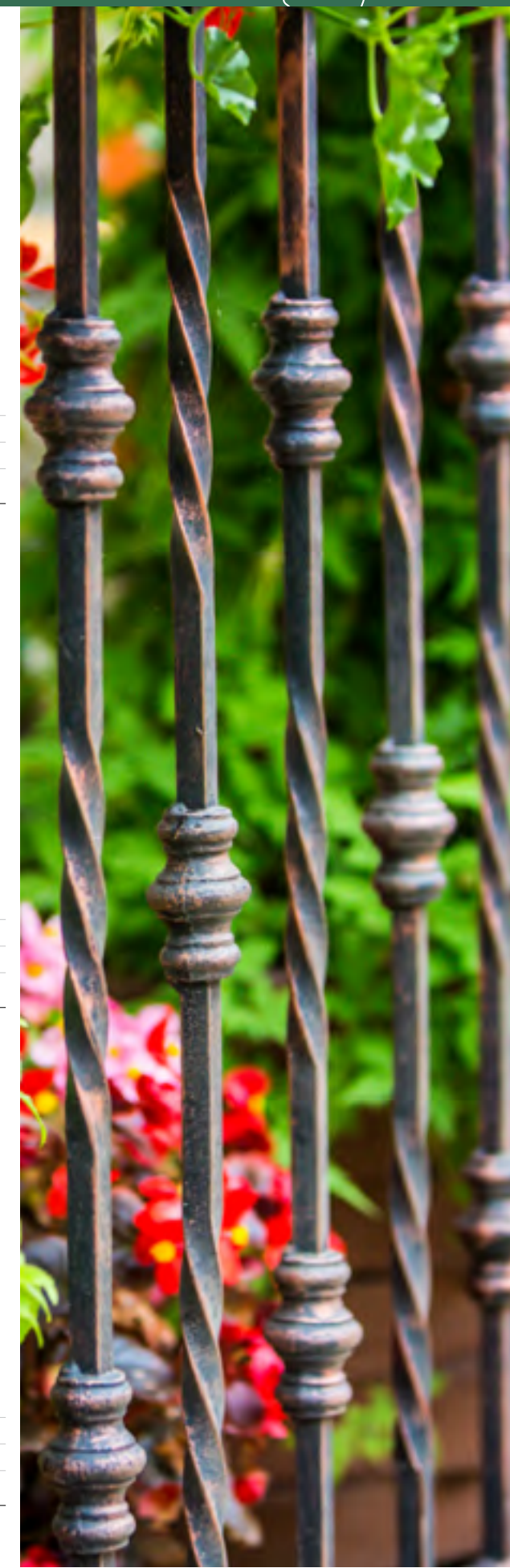







ŠIŠKY A KOULE

knobs and spheres / верхушки и шары / Pfostenaufsätze und Kugeln



			
□	ø28	ø40	ø50
H	80	90	90
N°	42.000	42.001	42.003





			
□	25x25	40x40	60x60
H	60	85	125
N°	42.004	42.005	42.005.01

			
□	ø27	ø42	ø48
H	60	85	125
N°	42.006	42.007	42.008

ŠIŠKY A KOULE

knobs and spheres / верхушки и шары / Pfostenaufsätze und Kugeln



				
□	ø30	ø45	ø55	
H	42	50	70	200x220
N°	42.011	42.012	42.013	42.030



ŠIŠKY A KOULE

knobs and spheres / верхушки и шары / Pfostenaufsätze und Kugeln

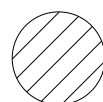

□	N°
∅15	43.015
∅20	43.020
∅25	43.025
∅30	43.030
∅35	43.035
∅40	43.040
∅50	43.050

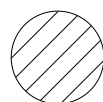

□	N°
∅20	43.120
∅25	43.125
∅30	43.130
∅35	43.135
∅40	43.140
∅50	43.150

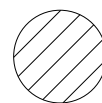

□	N°
∅30	43.230
∅40	43.240
∅50	43.250



≠	□	N°
1	∅50	43.505
1	∅60	43.506
1	∅70	43.507
1	∅80	43.508
1	∅100	43.510
1	∅120	43.512
1	∅150	43.515

ŠIŠKY A KOULE

knobs and spheres / верхушки и шары / Pfostenaufsätze und Kugeln

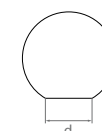

□	d	N°
∅15	8X8	43.615
∅20	10X10	43.620
∅25	12X12	43.625
∅30	14X14	43.630
∅35	14X14	43.635

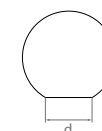

□	d	N°
∅40	∅20	43.640
∅50	∅25	43.650
∅60	∅30	43.660
∅70	∅35	43.670
∅80	∅40	43.680
∅90	∅45	43.690
∅100	∅53	43.700
∅120	∅61	43.720
∅150	∅80	43.750

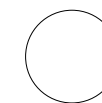

□	N°
∅60	43.660.01
∅80	43.680.01
∅100	43.700.01
∅120	43.720.01
∅200	43.800.01



ROZETY

masking frames / маскировочные элементы / Abschlußrosetten



≠	6	6	8
□	12x12	21x21	26x26
H	50	70	90
L	50	70	90
N°	44.001	44.004	44.006



≠	4	10	10
□			31x31
H	80	100	100
L	80	100	100
N°	44.010	44.011	44.013



≠	4	4	4
□		13x13	
H	78	78	100
L	78	78	100
N°	44.017	44.018	44.020

ROZETY

masking frames / маскировочные элементы / Abschlußrosetten



≠	4	4	4	4
□				25,5x25,5
H	ø67	ø95	ø108	ø115
N°	44.026	44.029	44.034	44.036



□	8	8	4	3,5
H	85	120	60	80
L	85	120	60	80
N°	44.038	44.039	44.040	44.043



ROZETY

masking frames / маскировочные элементы / Abschlußrosetten



□	H	L	N°
12,5x12,5/3,5	12	50x50	44.046
14,5x14,5/3	13	50x50	44.047
16,5x16,5/3	13	50x50	44.048
20,5x20,5/4	16	80x80	44.049
25,5x25,5/4	17	80x80	44.050
30,5x30,5/4	16	80x80	44.051
40,5x40,5/4	17	80x80	44.052



□	H	L	N°
40,5x20,5/4	17	80x80	44.053
30,5x40,5/3	17	80x80	44.054



□	H	L	N°
30,5x30,5	20	80x80	44.119
40,5x40,5	20	80x80	44.121
25,5x25,5	20	60x60	44.122
30,5x30,5	20	60x60	44.123
20,5x20,5	20	50x50	44.126
12,5x12,5	15	40x40	44.127
14,5x14,5	15	40x40	44.128
16,5x16,5	15	40x40	44.129



ROZETY

masking frames / маскировочные элементы / Abschlußrosetten



H	L	N°
20	ø60	44.134
20	ø40	44.136



□	H	L	N°
ø12,5	15	ø50	44.138
ø14	15	ø50	44.139
ø25	25	ø80	44.140
ø32	25	ø80	44.141
ø38	30	ø97	44.142
ø42	30	ø97	44.143
ø48	30	ø97	44.144
ø51	30	ø110	44.145

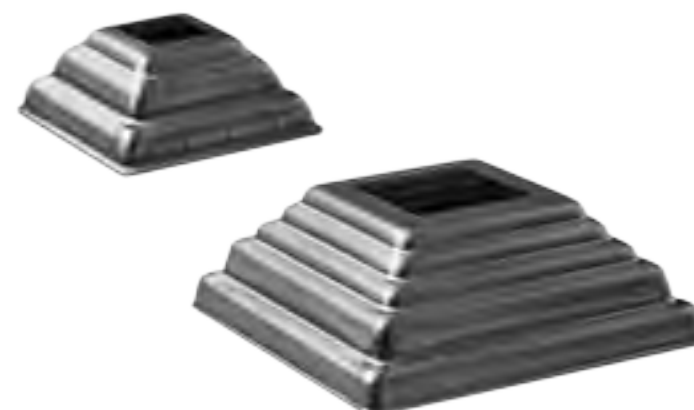

□	H	L	N°
12x12	19	44x44	44.146
14x14	19	44x44	44.147
16x16	19	44x44	44.148
20x20	22	57x57	44.149
25x25	30	80x80	44.150
30x30	30	80x80	44.151
40x40	30	90x90	44.152
50x50	30	100x100	44.153
60x60	28	109x109	44.154
80x80	28	120x120	44.155
100x100	28	140x140	44.156



□	H	L	N°
40x30	30	75x85	44.157
40x60	28	90x110	44.158
20x40	28	100x100	44.159

ROZETY

masking frames / маскировочные элементы / Abschlußrosetten

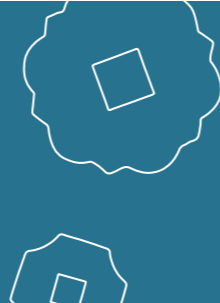

≠	4	4	6	3	3
□	14,5x14,5				
L		70	105	102	30
H	∅90	155	160	160	135
N°	44.060	44.200	44.205	44.206	44.220



≠	4	4	4	5
L	50	60	85	110
H	120	145	200	250
N°	44.201	44.202	44.203	44.204



≠	0,8	3	3	4	2	2
□					∅10	∅10
H	∅40	∅95	∅95	∅62	∅60	∅88
N°	50.000	50.001	50.003	50.004	50.005	50.006

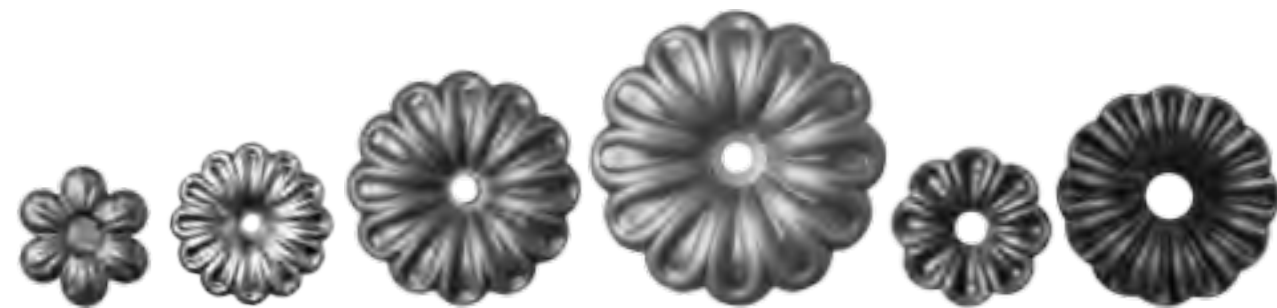

≠	2	0,8	2	2	2	3
□		∅12	∅10	∅12	∅12	∅18
H	∅57	∅68	∅95	∅120	∅60	∅90
N°	50.009	50.010	50.011	50.012	50.014	50.015



≠	2	2	2	1,5	0,8	0,8
□		∅10	∅10	∅8	∅8	∅7,5
H	∅100	∅140	∅85	35	70	115
N°	50.021	50.021.01	50.022	50.023	50.024	50.025

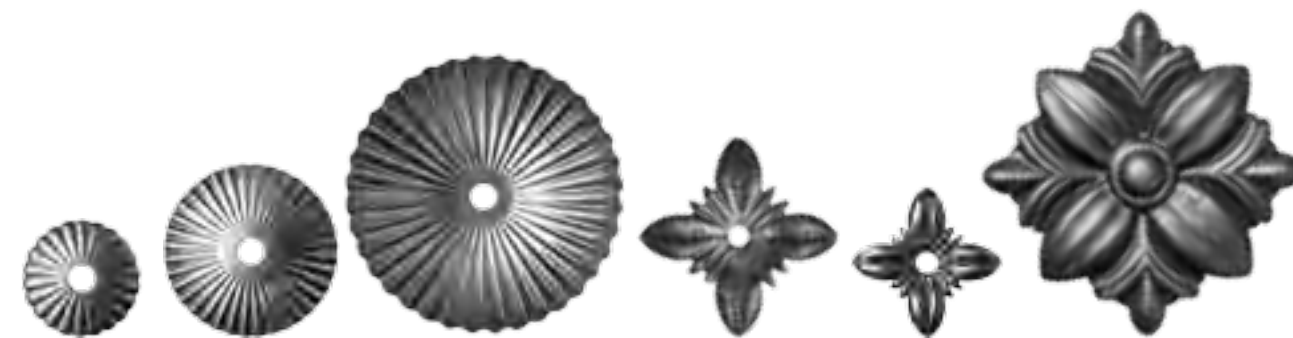

≠	0,8	0,8	0,8	1,5	1,5	2
□	∅5	∅10	∅20	∅8	∅8	
H	∅46	∅70	∅115	80	60	140
N°	50.029	50.030	50.031	50.032	50.033	50.046



≠	2	2	0,8	2	2	2
□	∅7	∅7				
H	∅85	∅120	∅100	∅85	∅115	∅95
N°	50.042	50.043	50.051	50.054	50.055	50.056



KVĚTY A LISTY

flowers and leaves / цветы и листья / Blumen und Blätter



≠	1,5	1,5	1,5	1,5
□	135	95	75	50
H	160	170	190	140
N°	50.061	50.062	50.063	50.064



≠	1,2	1,2	1,2
H	ø60	ø50	ø35
N°	50.095	50.096	50.097



L	200	70	125	45
H	450	100	200	60
N°	50.100	50.101	50.102	50.103

KVĚTY A LISTY

flowers and leaves / цветы и листья / Blumen und Blätter



≠			2	2
L	140	30	50	40
H	200	75	125	80
N°	50.104	50.105	50.106	50.107



≠	2	2	1	1,5	
L	50	40	33	50	90
H	115	80	45	50	340
N°	50.111	50.112	50.108	50.110	50.109





≠	2,5	2,5	2,5	2,5	40	40
L	150	170	210	240		
H	400	430	460	470	270	270
N°	50.113	50.114	50.115	50.116	50.117	50.118



L	115	50
H	400	420
N°	50.120	50.121



≠	2,5	2,5	2,5
L	40	30	40
H	80	65	115
N°	50.122	50.122.01	50.123



L	140	115	40
H	320	320	350
N°	50.124	50.124.01	50.125



KVĚTY A LISTY

flowers and leaves / цветы и листья / Blumen und Blätter



≠			2	2
L	105	90	70	50
H	300	300	115	85
N°	50.130	50.131	50.133	50.134



≠	2	2	2	2
L	260	220	170	150
H	250	210	180	160
N°	50.135	50.136	50.137	50.138



≠	2,5	2,5	2,5	∅20	∅20
L	40	40	30	20	85
H	130	114	90	85	85
N°	50.143	50.143.01	50.143.02	50.144	50.146

KVĚTY A LISTY

flowers and leaves / цветы и листья / Blumen und Blätter



≠	2	2	1,5
L	105	80	55
H	190	140	100
N°	50.147	50.148	50.149



≠	2	2	2
L	90	75	55
H	170	140	100
N°	50.150	50.151	50.152



≠	25	20	4
L			45
H	95	56	65
N°	50.153	50.154	50.155

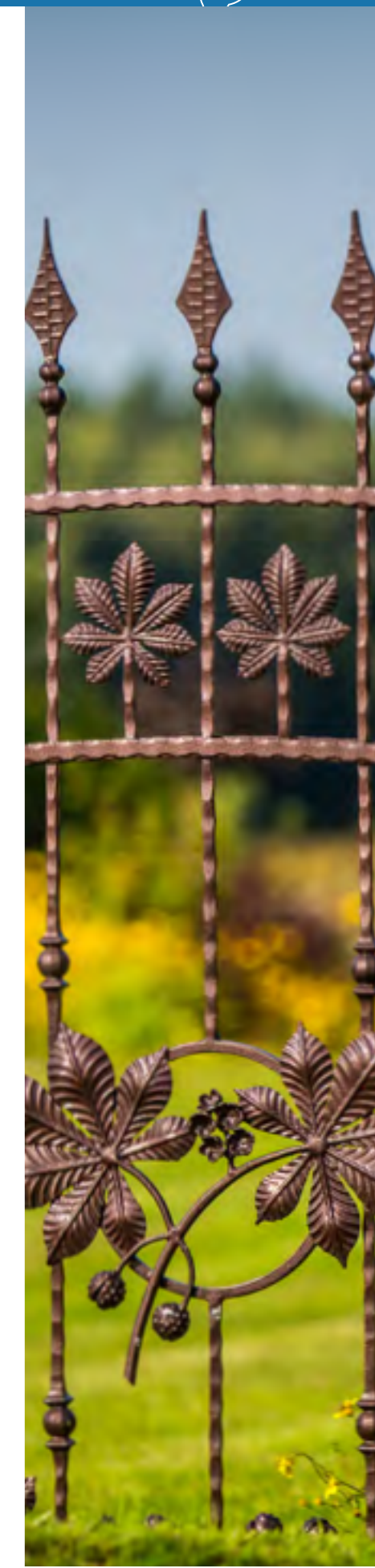

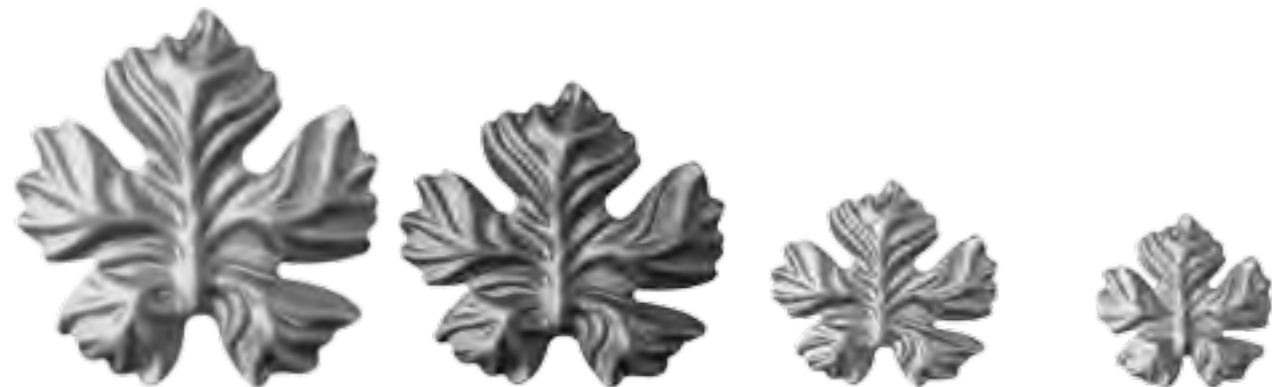

≠	2	2	2	2
L	150	115	95	70
H	150	125	85	70
N°	50.156	50.157	50.158	50.159



≠	1,5	1,5	1,5	60	60
L	100	75	50	60	60
H	105	75	50	160	120
N°	50.160	50.161	50.162	50.165	50.166



≠	12	12	2	2	2
L	190	190	130	110	75
H	430	430	195	155	115
N°	50.175	50.176	50.181	50.182	50.183



≠	2	2	2	4
L	230	180	110	45
H	235	210	140	85
N°	50.184	50.185	50.186	50.187



≠	2	2	2	2
L	175	105	45	110
H	410	275	250	160
N°	50.188	50.189	50.190	50.191



KVĚTY A LISTY

flowers and leaves / цветы и листья / Blumen und Blätter



≠				1,5	1,5
L	75	110	110		
H	210	200	200	460	305
N°	50.195	50.196	50.197	50.198	50.199



≠	2	2	2	2
L	200	140	166	142
H	115	85	175	150
N°	50.200	50.201	50.209	50.210

KVĚTY A LISTY

flowers and leaves / цветы и листья / Blumen und Blätter



≠	2	2	2		
L	140	105	70	70	55
H	120	90	60	340	340
N°	50.211	50.212	50.213	50.214	50.215



≠	2	2	2	2	2
L	200	155	125	95	125
H	190	165	135	100	35
N°	50.216	50.217	50.218	50.219	50.220



≠	1,5	1,5	1,5
L	60	55	45
H	240	210	180
N°	50.222	50.223	50.224

KVĚTY A LISTY

flowers and leaves / цветы и листья / Blumen und Blätter



≠	2	2	1,5	1,5
L	54	55	135	135
H	130	130	130	130
N°	50.229	50.230	50.231	50.232



≠	2,5	2,5	2,5	2,5
L	140	70	150	70
H	200	190	260	240
N°	50.236	50.237	50.238	50.239



≠	2,5	2,5	2,5	2,5
L	120	60	60	85
H	370	350	350	280
N°	50.240	50.241	50.242	50.243

KVĚTY A LISTY

flowers and leaves / цветы и листья / Blumen und Blätter

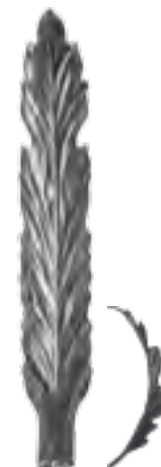

≠	2,5	2,5	2,5	2,5
L	50	50	175	175
H	250	250	200	200
N°	50.244	50.245	50.253	50.254



≠	2,5	2,5	2,5	2,5
L	200	200	100	100
H	210	210	270	270
N°	50.255	50.256	50.257	50.258





≠	2,5	2,5	2	2	2	2
L	50	50	92	92	60	60
H	90	90	112	112	80	80
N°	51.003	51.004	51.015	51.016	51.017	51.018



≠	2	2	2	2	2	2
L	69	69	40	40	30	30
H	185	185	110	110	90	90
N°	51.059	51.060	51.061	51.062	51.063	51.064



≠	2	2	2	2	2	2
L	60	60	70	70	75	75
H	80	80	65	65	110	110
N°	51.069	51.070	51.073	51.074	51.077	51.078



≠	2	2	2	2	2	2
L	48	45	47	72	45	60
H	88	108	150	100	160	280
N°	51.079	51.080	51.082	51.083	51.097	51.098



≠	3	2,5	2,5	2,5	3	3
L	50	38	60	75	60	55
H	105	125	150	150	300	290
N°	51.099	51.101	51.102	51.103	51.104	51.105

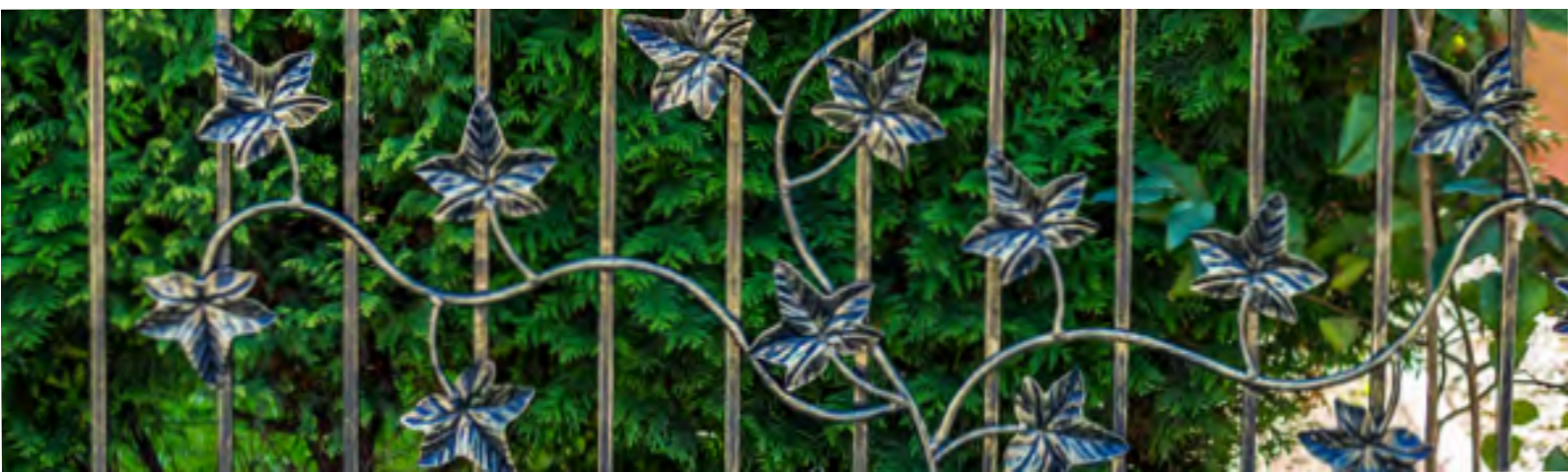



≠	4	4	4	2	1,5
L	110	92	100	100	135
H	350	295	330	260	70
N°	51.106	51.107	51.108	51.108.01	51.110



≠	1,8	1,8	4	4
L	150	150	175	175
H	100	100	215	215
N°	51.113	51.114	51.115	51.116



≠	2	2	2	2
L	95	95	175	175
H	200	200	295	295
N°	51.121	51.122	51.123	51.124



≠	2	2	2	2
L	135	135	130	130
H	230	230	164	164
N°	51.125	51.126	51.127	51.128



KVĚTY A LISTY

flowers and leaves / цветы и листья / Blumen und Blätter



№	2	2	2	2
L	140	140	140	140
H	240	240	240	240
N°	51.129	51.130	51.133	51.134

KVĚTY A LISTY

flowers and leaves / цветы и листья / Blumen und Blätter



№	2	2	2	2
L	95	95	130	72
H	110	110	143	85
N°	51.153	51.154	51.235	51.236



№	2	2	2	1,2
L	210	210	145	180
H	340	340	243	260
N°	51.240	51.241	51.251	51.252



№	2	2	2	2	2
L	75	50	50	56	70
H	260	255	235	285	240
N°	51.140	51.143	51.144	51.145	51.147



KVĚTY A LISTY

flowers and leaves / цветы и листья / Blumen und Blätter



≠	2	2	0,8
L	180	165	110
H	260	165	110
N°	51.253	51.254	51.418



≠	1,2	2
L	300	50
H	225	225
N°	51.451	51.452



≠	0,8
L	570
H	120
N°	51.427



≠	0,8
L	1000
H	80
N°	51.449



≠	4	4	4	4
L	95	95	155	155
H	120	120	280	280
N°	52.003	52.004	52.005	52.006



≠	4	4	4	4
L	65	65	115	115
H	140	140	180	180
N°	52.009	52.010	52.011	52.012



≠	4	4	4	4
L	110	110	160	160
H	140	140	190	190
N°	52.013	52.014	52.015	52.016



≠	4	4	4	4
L	140	140	150	150
H	155	155	250	250
N°	52.017	52.018	52.019	52.020



≠	4	4	4	4
L	135	135	85	85
H	210	210	180	180
N°	52.021	52.022	52.023	52.024



≠	4	4	4	4
L	125	125	140	75
H	165	165	215	170
N°	52.025	52.026	52.029	52.030



≠	4	4	5	4
L	105	55	60	75
H	235	115	190	135
N°	52.034	52.043	52.044	52.047



≠	4	2	4
L	75	110	80
H	125	155	122
N°	52.201	52.202	52.203



≠	4	4	4	4
L	120	120	ø150	ø90
H	220	220	45	45
N°	52.049	52.050	52.130	52.131



L	100	130
H	145	200
N°	52.211	52.212



≠	3	3,5	5	3
H	ø90	ø90	ø115	ø50
N°	52.132	52.133	52.134	52.139



□	ø5	ø5
L	28	43
H	180	160
N°	52.216	52.217





≠	8	8	8
H	ø85	ø55	ø88
N°	52.300	52.301	52.305



≠	8	10
L	100	135
H	195	210
N°	52.406	52.420



≠	0,5	0,5	0,5
L		45	35
H	ø80	85	70
N°	53.000	53.008	53.009



≠	14x14	14x14	14x14
L	190	175	200
H	380	400	455
N°	55.001	55.003	55.005

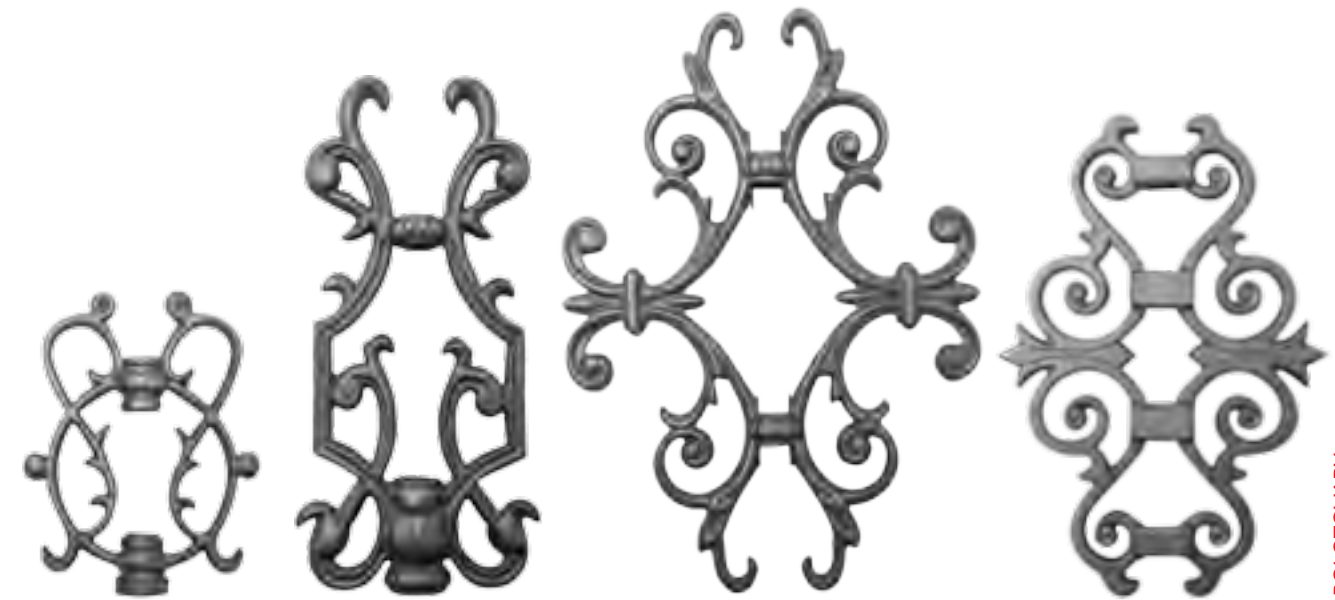

≠	14x14	14x14	14x14	14x14
L	138	130	225	180
H	165	280	315	260
N°	55.006	55.007	55.008	55.009

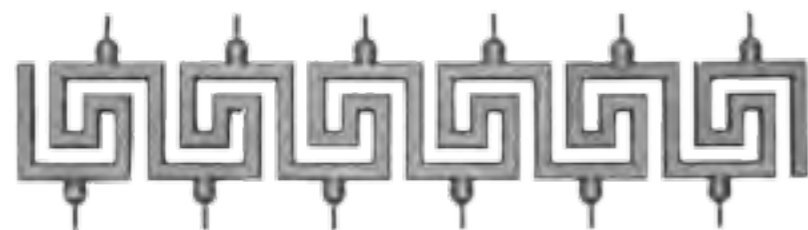

H	140
L	500
N°	55.030

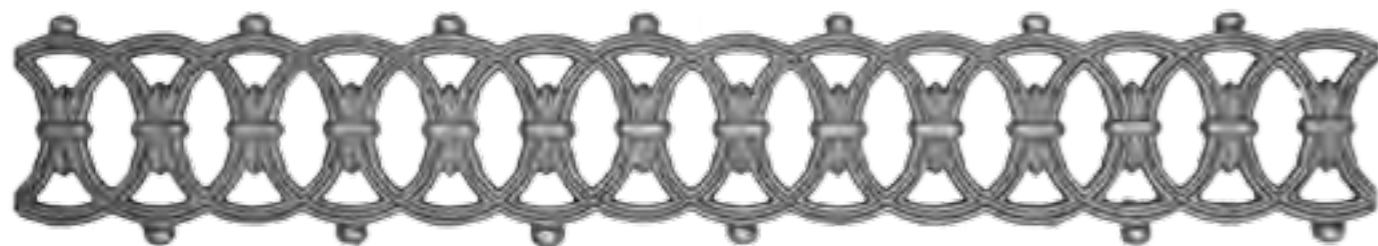

H	150
L	870
N°	55.031

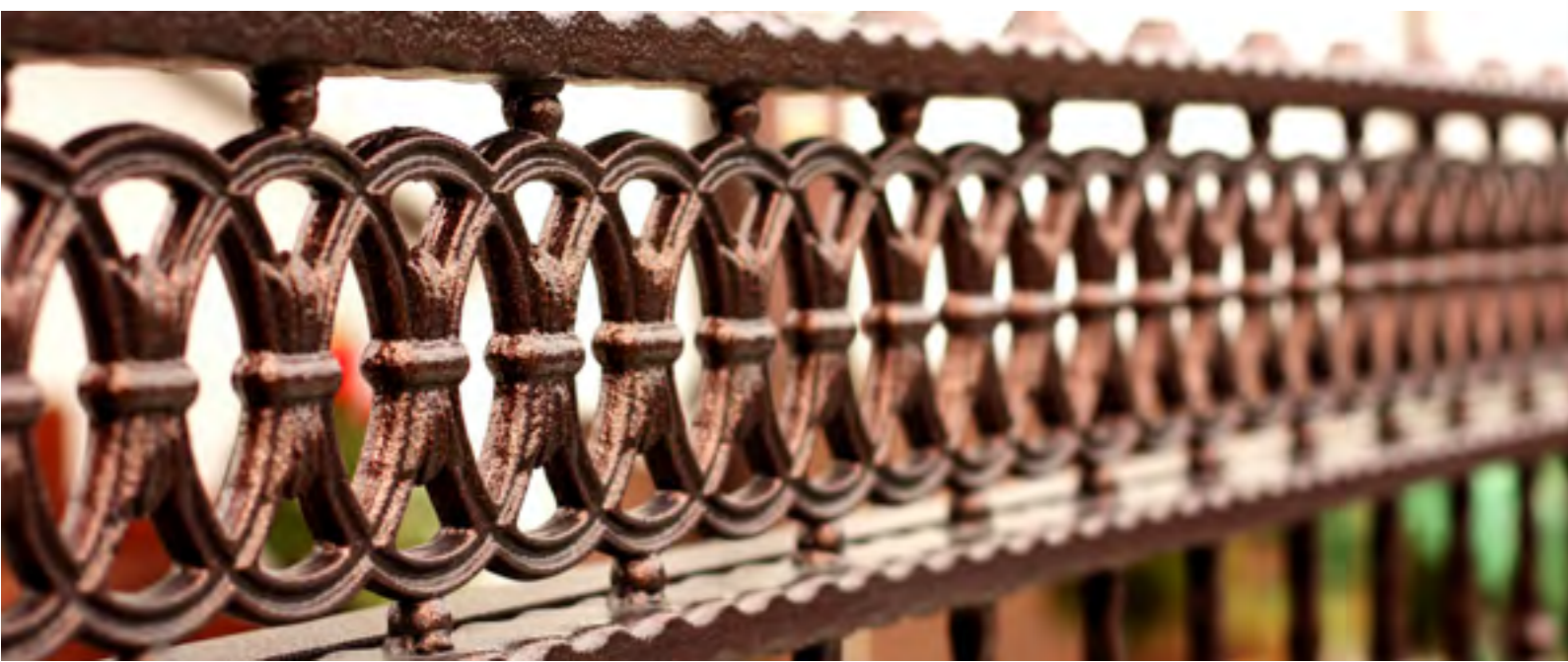

L	165
H	250
N°	55.050 55.200



□	100
L	110
H	210
N°	55.100



□	40	50	60	80	100
L	40	50	60	80	100
H	87	110	135	160	180
N°	55.101	55.102	55.103	55.104	55.105

